



STEREO AUDIO CODEC WITH USB INTERFACE, SINGLE-ENDED ANALOG INPUT/OUTPUT AND S/PDIF

FEATURES

- **PCM2900: Without S/PDIF**
- **PCM2902: With S/PDIF**
- **On-Chip USB Interface:**
 - With Full-Speed Transceivers
 - Fully Compliant With USB 1.1 Specification
 - Certified by USB-IF
 - Partially Programmable Descriptors⁽¹⁾
 - USB Adaptive Mode for Playback
 - USB Asynchronous Mode for Record
 - Bus Powered
- **16-Bit Delta Sigma ADC and DAC**
- **Sampling Rate:**
 - DAC: 32, 44.1, 48 kHz
 - ADC: 8, 11.025, 16, 22.05, 32, 44.1, 48 kHz
- **On-Chip Clock Generator:**
 - With Single 12-MHz Clock Source
- **Single Power Supply: 5 V TYP (V_{BUS})**
- **Stereo ADC**
 - Analog Performance at $V_{BUS} = 5 V$
 - THD+N = 0.01%
 - SNR = 89 dB
 - Dynamic Range = 89 dB
 - Decimation Digital Filter
 - Pass-Band Ripple = ± 0.05 dB
 - Stop-Band Attenuation = –65 dB
 - Single-Ended Voltage Input
 - Antialiasing Filter Included
 - Digital LCF Included

- **Stereo DAC**
 - Analog Performance at $V_{BUS} = 5 V$
 - THD+N = 0.005%
 - SNR = 96 dB
 - Dynamic Range = 93 dB
 - Oversampling Digital Filter
 - Pass-Band Ripple = ± 0.1 dB
 - Stop-Band Attenuation = –43 dB
 - Single-Ended Voltage Output
 - Analog LPF Included
- **Multifunctions:**
 - Human Interface Device (HID) Volume \pm Control and Mute Control
 - Suspend Flag
- **Package: 28-Pin SSOP**

APPLICATIONS

- USB Audio Speaker
- USB Headset
- USB Monitor
- USB Audio Interface Box

DESCRIPTION

The PCM2900/2902 is Texas Instruments single-chip USB stereo audio codec with USB-compliant full-speed protocol controller and S/PDIF (only PCM2902). The USB protocol controller works with no software code, but the USB descriptors can be modified in some areas (e.g., vendor ID/product ID). The PCM2900/2902 employs SpAct™ architecture, TI's unique system that recovers the audio clock from USB packet data. On-chip analog PLLs with SpAct enable playback and record with low clock jitter and with independent playback and record sampling rates.



Please be aware that an important notice concerning availability, standard warranty, and use in critical applications of Texas Instruments semiconductor products and disclaimers thereto appears at the end of this data sheet.

⁽¹⁾The descriptor can be modified by changing a mask.

SpAct is a trademark of Texas Instruments, Incorporated.

Apple, Mac, and Mac OS are trademarks of Apple Computer, Inc.

Intel is a trademark of Intel Corporation.

Microsoft, Windows, Windows Me, and Windows XP are trademarks of Microsoft Corporation.

Other trademarks are the property of their respective owners.



This integrated circuit can be damaged by ESD. Texas Instruments recommends that all integrated circuits be handled with appropriate precautions. Failure to observe proper handling and installation procedures can cause damage. ESD damage can range from subtle performance degradation to complete device failure. Precision integrated circuits may be more susceptible to damage because very small parametric changes could cause the device not to meet its published specifications.

PACKAGING ORDERING INFORMATION

| PCM2900 | | | | | | |
|----------|--------------|--------------------|-----------------------------|-----------------|--------------------|-----------------|
| PRODUCT | PACKAGE-LEAD | PACKAGE DESIGNATOR | SPECIFIED TEMPERATURE RANGE | PACKAGE MARKING | ORDERING NUMBER(1) | TRANSPORT MEDIA |
| PCM2900E | SSOP-28 | 28DB | -25°C to 85°C | PCM2900E | PCM2900E | Rails |
| | | | | | PCM2900E/2K | Tape and reel |

(1) Models with a slash (/) are available only in tape and reel in the quantities indicated (e.g., /2K indicates 2000 devices per reel). Ordering 2000 pieces of PCM2900E/2K gets a single 2000-piece tape and reel.

| PCM2902 | | | | | | |
|----------|--------------|--------------------|-----------------------------|-----------------|--------------------|-----------------|
| PRODUCT | PACKAGE-LEAD | PACKAGE DESIGNATOR | SPECIFIED TEMPERATURE RANGE | PACKAGE MARKING | ORDERING NUMBER(1) | TRANSPORT MEDIA |
| PCM2902E | SSOP-28 | 28DB | -25°C to 85°C | PCM2902E | PCM2902E | Rails |
| | | | | | PCM2902E/2K | Tape and reel |

(1) Models with a slash (/) are available only in tape and reel in the quantities indicated (e.g., /2K indicates 2000 devices per reel). Ordering 2000 pieces of PCM2902E/2K gets a single 2000-piece tape and reel.

ABSOLUTE MAXIMUM RATINGS

over operating free-air temperature range unless otherwise noted(1)

| | | PCM2900/PCM2902 | UNIT |
|---|---|--------------------------------|---------|
| Supply voltage, V_{BUS} | | -0.3 to 6.5 | V |
| Ground voltage differences, AGND _C , AGND _P , AGND _X , DGND, DGND _U | | ±0.1 | V |
| Digital input voltage | SEL0, SEL1, TEST0 (DIN)(2) | -0.3 to 6.5 | V |
| | D+, D-, HID0, HID1, HID2, XT1, XTO, TEST1 (DOUT)(2), \overline{SSPND} | -0.3 to $(V_{DDI} + 0.3) < 4$ | V |
| Analog input voltage | V_{INL} , V_{INR} , V_{COM} , V_{OUTR} , V_{OUTL} | -0.3 to $(V_{CCCI} + 0.3) < 4$ | V |
| | V_{CCCI} , V_{CCP1} , V_{CCP2} , V_{CCXI} , V_{DDI} | -0.3 to 4 | V |
| Input current (any pins except supplies) | | ±10 | mA |
| Ambient temperature under bias | | -40 to 125 | °C |
| Storage temperature, T_{stg} | | -55 to 150 | °C |
| Junction temperature T_J | | 150 | °C |
| Lead temperature (soldering) | | 260 | °C, 5 s |
| Package temperature (IR reflow, peak) | | 250 | °C |

(1) Stresses beyond those listed under “absolute maximum ratings” may cause permanent damage to the device. These are stress ratings only, and functional operation of the device at these or any other conditions beyond those indicated under “recommended operating conditions” is not implied. Exposure to absolute-maximum-rated conditions for extended periods may affect device reliability.

(2) (): PCM2902

ELECTRICAL CHARACTERISTICS

 all specifications at $T_A = 25^\circ\text{C}$, $V_{\text{BUS}} = 5\text{ V}$, $f_S = 44.1\text{ kHz}$, $f_{\text{IN}} = 1\text{ kHz}$, 16-bit data, unless otherwise noted

| PARAMETER | | TEST CONDITIONS | PCM2900E, PCM2902E | | | UNIT |
|-----------------------------|---------------------------|------------------------------------|--------------------------------|-------|----------|---------------|
| | | | MIN | TYP | MAX | |
| Digital Input/Output | | | | | | |
| Host interface | | Apply USB Revision 1.1, full speed | | | | |
| Audio data format | | USB isochronous data format | | | | |
| Input Logic | | | | | | |
| V_{IH} | High-level input voltage | D+, D- | | 2 | 3.3 | VDC |
| | | XTI, HID0, HID1, and HID2 | | 2.52 | 3.3 | |
| | | SEL0, SEL1 | | 2 | 5.25 | |
| | | DIN, PCM2902 | | 2.52 | 5.25 | |
| V_{IL} | Low-level input voltage | D+, D- | | | 0.8 | VDC |
| | | XTI, HID0, HID1, and HID2 | | | 0.9 | |
| | | SEL0, SEL1 | | | 0.8 | |
| | | DIN, PCM2902 | | | 0.9 | |
| I_{IH} | High-level input current | D+, D-, XTI, SEL0, SEL1 | $V_{\text{IN}} = 3.3\text{ V}$ | | ± 10 | μA |
| | | HID0, HID1, and HID2 | $V_{\text{IN}} = 3.3\text{ V}$ | 50 | 80 | |
| | | DIN, PCM2902 | $V_{\text{IN}} = 3.3\text{ V}$ | 65 | 100 | |
| I_{IL} | Low-level input current | D+, D-, XTI, SEL0, SEL1 | $V_{\text{IN}} = 0\text{ V}$ | | ± 10 | μA |
| | | HID0, HID1, and HID2 | $V_{\text{IN}} = 0\text{ V}$ | | ± 10 | |
| | | DIN, PCM2902 | $V_{\text{IN}} = 0\text{ V}$ | | ± 10 | |
| Output Logic | | | | | | |
| V_{OH} | High-level output voltage | D+, D- | | 2.8 | | VDC |
| | | DOUT, PCM2902 | $I_{\text{OH}} = -4\text{ mA}$ | 2.8 | | |
| | | SSPND | $I_{\text{OH}} = -2\text{ mA}$ | 2.8 | | |
| V_{OL} | Low-level output voltage | D+, D- | | | 0.3 | VDC |
| | | DOUT, PCM2902 | $I_{\text{OL}} = 4\text{ mA}$ | | 0.5 | |
| | | SSPND | $I_{\text{OL}} = 2\text{ mA}$ | | 0.5 | |
| Clock Frequency | | | | | | |
| Input clock frequency, XTI | | | 11.994 | 12 | 12.006 | MHz |
| ADC Characteristics | | | | | | |
| Resolution | | | | 8, 16 | | bits |
| Audio data channel | | | | 1, 2 | | channel |

ELECTRICAL CHARACTERISTICS

all specifications at $T_A = 25^\circ\text{C}$, $V_{BUS} = 5\text{ V}$, $f_S = 44.1\text{ kHz}$, $f_{IN} = 1\text{ kHz}$, 16-bit data, unless otherwise noted

| PARAMETER | TEST CONDITIONS | PCM2900E, PCM2902E | | | UNIT |
|--|--|------------------------------------|-------------------|-------------|------------|
| | | MIN | TYP | MAX | |
| Clock Frequency | | | | | |
| f_S Sampling frequency | | 8, 11.025, 16, 22.05, 32, 44.1, 48 | | | kHz |
| DC Accuracy | | | | | |
| Gain mismatch channel-to-channel | | | ± 1 | ± 5 | % of FSR |
| Gain error | | | ± 2 | ± 10 | % of FSR |
| Bipolar zero error | | | ± 0 | | % of FSR |
| Dynamic Performance⁽¹⁾ | | | | | |
| THD+N Total harmonic distortion plus noise | $V_{CCCI} = 3.67\text{ V}$, $V_{IN} = -0.5\text{ dB}^{(2)}$ | | 0.01% | 0.02% | |
| | $V_{IN} = -0.5\text{ dB}^{(3)}$ | | 0.1% | | |
| | $V_{IN} = -60\text{ dB}$ | | 5% | | |
| Dynamic range | A-weighted | 81 | 89 | | dB |
| SNR Signal-to-noise ratio | A-weighted | 81 | 89 | | dB |
| Channel separation | | 80 | 85 | | dB |
| Analog Input | | | | | |
| Input voltage | | | 0.6 V_{CCCI} | | V_{p-p} |
| Center voltage | | | 0.5 V_{CCCI} | | V |
| Input impedance | | | 30 | | k Ω |
| Antialiasing filter frequency response | -3 dB | | 150 | | kHz |
| | $f_{IN} = 20\text{ kHz}$ | | -0.08 | | dB |
| Digital Filter Performance | | | | | |
| Pass band | | | | 0.454 f_S | Hz |
| Stop band | | | | 0.583 f_S | Hz |
| Pass-band ripple | | | | ± 0.05 | dB |
| Stop-band attenuation | | | -65 | | dB |
| t_d Delay time | | | 17.4/ f_S | | s |
| LCF frequency response | -3 dB | | 0.078 f_S | | MHz |
| DAC Characteristics | | | | | |
| Resolution | | | 8, 16 | | bits |
| Audio data channel | | | 1, 2 | | channel |
| Clock Frequency | | | | | |
| f_S Sampling frequency | | | 32, 44.1, 48 | | kHz |

(1) $f_{IN} = 1\text{ kHz}$, using Audio Precision System II, RMS mode with 20-kHz LPF, 400-Hz HPF in calculation.

(2) Using external voltage regulator for V_{CCCI} (as shown in Figure 36 and Figure 37, using with REG103xA-A)

(3) Using internal voltage regulator for V_{CCCI} (as shown in Figure 38 and Figure 39)

ELECTRICAL CHARACTERISTICS

all specifications at $T_A = 25^\circ\text{C}$, $V_{\text{BUS}} = 5\text{ V}$, $f_S = 44.1\text{ kHz}$, $f_{\text{IN}} = 1\text{ kHz}$, 16-bit data, unless otherwise noted

| PARAMETER | | TEST CONDITIONS | PCM2900E, PCM2902E | | | UNIT |
|--|--------------------------------------|---|--------------------|--------------------------|-------------|--------------------|
| | | | MIN | TYP | MAX | |
| DC Accuracy | | | | | | |
| | Gain mismatch channel-to-channel | | | ± 1 | ± 5 | % of FSR |
| | Gain error | | | ± 2 | ± 10 | % of FSR |
| | Bipolar zero error | | | ± 2 | | % of FSR |
| Dynamic Performance⁽¹⁾ | | | | | | |
| THD+N | Total harmonic distortion plus noise | $V_{\text{OUT}} = 0\text{ dB}$ | | 0.005% | 0.016% | |
| | | $V_{\text{OUT}} = -60\text{ dB}$ | | 3% | | |
| | Dynamic range | EIAJ, A-weighted | 87 | 93 | | dB |
| SNR | Signal-to-noise ratio | EIAJ, A-weighted | 90 | 96 | | dB |
| | Channel separation | | 86 | 92 | | dB |
| Analog Output | | | | | | |
| V_O | Output voltage | | | 0.6 V_{CCCI} | | $V_{\text{p-p}}$ |
| | Center voltage | | | 0.5 V_{CCCI} | | V |
| | Load impedance | AC coupling | 10 | | | k Ω |
| | LPF frequency response | -3 dB | | 250 | | kHz |
| | | $f = 20\text{ kHz}$ | | -0.03 | | dB |
| | Digital filter performance | | | | | |
| | Pass band | | | | 0.445 f_S | Hz |
| | Stop band | | 0.555 f_S | | | Hz |
| | Pass-band ripple | | | | ± 0.1 | dB |
| | Stop-band attenuation | | -43 | | | dB |
| t_d | Delay time | | | 14.3 f_S | | s |
| Power Supply Requirements | | | | | | |
| V_{BUS} | Voltage range | | 4.35 | 5 | 5.25 | VDC |
| | Supply current | ADC, DAC operation | | 56 | 67 | mA |
| | | Suspend mode ⁽²⁾ | | 210 | | μA |
| P_D | Power dissipation | ADC, DAC operation | | 280 | 352 | mW |
| | | Suspend mode ⁽²⁾ | | 1.05 | | mW |
| | Internal power supply voltage | V_{CCCI} , V_{CCP1} , V_{CCP2} , V_{CCX1} , and V_{DDI} | 3.25 | 3.35 | 3.5 | VDC |
| Temperature Range | | | | | | |
| | Operation temperature | | -25 | | 85 | $^\circ\text{C}$ |
| θ_{JA} | Thermal resistance | 28-pin SSOP | | 100 | | $^\circ\text{C/W}$ |

⁽¹⁾ $f_{\text{OUT}} = 1\text{ kHz}$, using Audio Precision System II, RMS mode with 20-kHz LPF, 400-Hz HPF.

⁽²⁾ Under USB suspend state

PIN ASSIGNMENTS

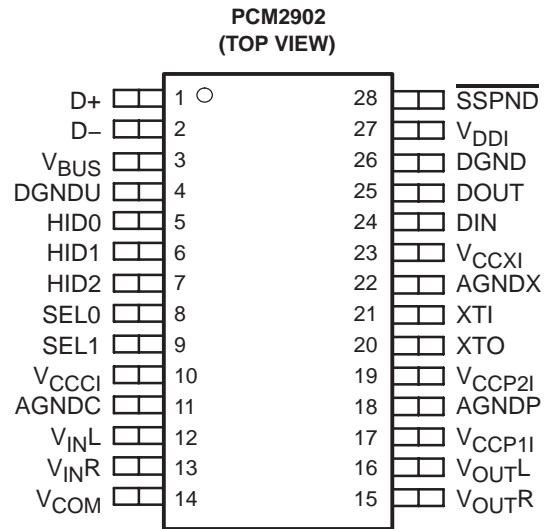
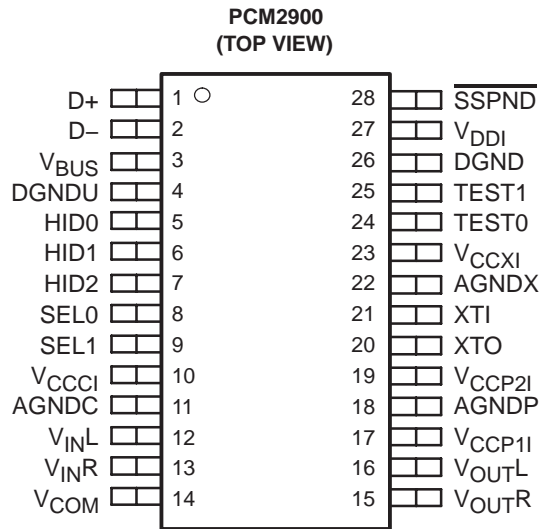

PCM2900 Terminal Functions

| TERMINAL | | I/O | DESCRIPTION |
|--------------------|-----|-----|---|
| NAME | NO. | | |
| SSPND | 28 | O | Suspend flag, active low (Low: suspend, High: operational) |
| AGNDC | 11 | – | Analog ground for codec |
| AGNDP | 18 | – | Analog ground for PLL |
| AGNDX | 22 | – | Analog ground for oscillator |
| D– | 2 | I/O | USB differential input/output minus ⁽¹⁾ |
| D+ | 1 | I/O | USB differential input/output plus ⁽¹⁾ |
| DGND | 26 | – | Digital ground |
| DGNDU | 4 | – | Digital ground for USB transceiver |
| HID0 | 5 | I | HID key state input (mute), active high ⁽³⁾ |
| HID1 | 6 | I | HID key state input (volume up), active high ⁽³⁾ |
| HID2 | 7 | I | HID key state input (volume down), active high ⁽³⁾ |
| SEL0 | 8 | I | Must be set to high ⁽⁵⁾ |
| SEL1 | 9 | I | Must be set to high ⁽⁵⁾ |
| TEST0 | 24 | I | Test pin, must be connected to GND |
| TEST1 | 25 | O | Test pin, must be left open |
| V _{BUS} | 3 | – | Connect to USB power (V _{BUS}) |
| V _{CCCI} | 10 | – | Internal analog power supply for codec ⁽⁴⁾ |
| V _{CCP1I} | 17 | – | Internal analog power supply for PLL ⁽⁴⁾ |
| V _{CCP2I} | 19 | – | Internal analog power supply for PLL ⁽⁴⁾ |
| V _{CCXI} | 23 | – | Internal analog power supply for oscillator ⁽⁴⁾ |
| V _{COM} | 14 | – | Common for ADC/DAC (V _{CCCI} /2) ⁽⁴⁾ |
| V _{DDI} | 27 | – | Internal digital power supply ⁽⁴⁾ |
| V _{INL} | 12 | I | ADC analog input for L-channel |
| V _{INR} | 13 | I | ADC analog input for R-channel |
| V _{OUTL} | 16 | O | DAC analog output for L-channel |
| V _{OUTR} | 15 | O | DAC analog output for R-channel |
| XTI | 21 | I | Crystal oscillator input ⁽²⁾ |
| XTO | 20 | O | Crystal oscillator output |

(1) LV-TTL level

(2) 3.3-V CMOS level input

(3) 3.3-V CMOS level input with internal pulldown. This pin informs the PC of serviceable control signals such as mute, volume up, or volume down, which has no connection with the internal DAC or ADC directly. See the *Interface #3* and *End-Points* sections.

(4) Connect a decouple capacitor to GND

(5) TTL Schmitt trigger, 5 V tolerant

PCM2902 Terminal Functions

| TERMINAL NAME | PIN | I/O | DESCRIPTIONS |
|------------------|-----|-----|---|
| SSPND | 28 | O | Suspend flag, active low (Low: suspend, High: operational) |
| AGND | 11 | – | Analog ground for codec |
| AGNDP | 18 | – | Analog ground for PLL |
| AGNDX | 22 | – | Analog ground for oscillator |
| D– | 2 | I/O | USB differential input/output minus ⁽¹⁾ |
| D+ | 1 | I/O | USB differential input/output plus ⁽¹⁾ |
| DGND | 26 | – | Digital ground |
| DGNDU | 4 | – | Digital ground for USB transceiver |
| DIN | 24 | I | S/PDIF input ⁽⁵⁾ |
| DOUT | 25 | O | S/PDIF output |
| HID0 | 5 | I | HID key state input (mute), active high ⁽³⁾ |
| HID1 | 6 | I | HID key state input (volume up), active high ⁽³⁾ |
| HID2 | 7 | I | HID key state input (volume down), active high ⁽³⁾ |
| SEL0 | 8 | I | Must be set to high ⁽⁶⁾ |
| SEL1 | 9 | I | Must be set to high ⁽⁶⁾ |
| VBUS | 3 | – | Connect to USB power (VBUS) |
| VCCCI | 10 | – | Internal analog power supply for codec ⁽⁴⁾ |
| VCCP1I | 17 | – | Internal analog power supply for PLL ⁽⁴⁾ |
| VCCP2I | 19 | – | Internal analog power supply for PLL ⁽⁴⁾ |
| VCCXI | 23 | – | Internal analog power supply for oscillator ⁽⁴⁾ |
| VCOM | 14 | – | Common for ADC/DAC (VCCCI/2) ⁽⁴⁾ |
| VDDI | 27 | – | Internal digital power supply ⁽⁴⁾ |
| VINL | 12 | I | ADC analog input for L-channel |
| VINR | 13 | I | ADC analog input for R-channel |
| VOUPL | 16 | O | DAC analog output for L-channel |
| VOUPL | 15 | O | DAC analog output for R-channel |
| XTI | 21 | I | Crystal oscillator input ⁽²⁾ |
| XTO | 20 | O | Crystal oscillator output |

(1) LV-TTL level

(2) 3.3-V CMOS level input

(3) 3.3-V CMOS level input with internal pulldown. This pin informs the PC of serviceable control signals such as mute, volume up, or volume down, which has no connection with the internal DAC or ADC directly. See the *Interface #3* and *End-Points* sections.

(4) Connect a decouple capacitor to GND

(5) 3.3-V CMOS level input with internal pulldown, 5 V tolerant

(6) TTL Schmitt trigger, 5 V tolerant

PCM2900 FUNCTIONAL BLOCK DIAGRAM

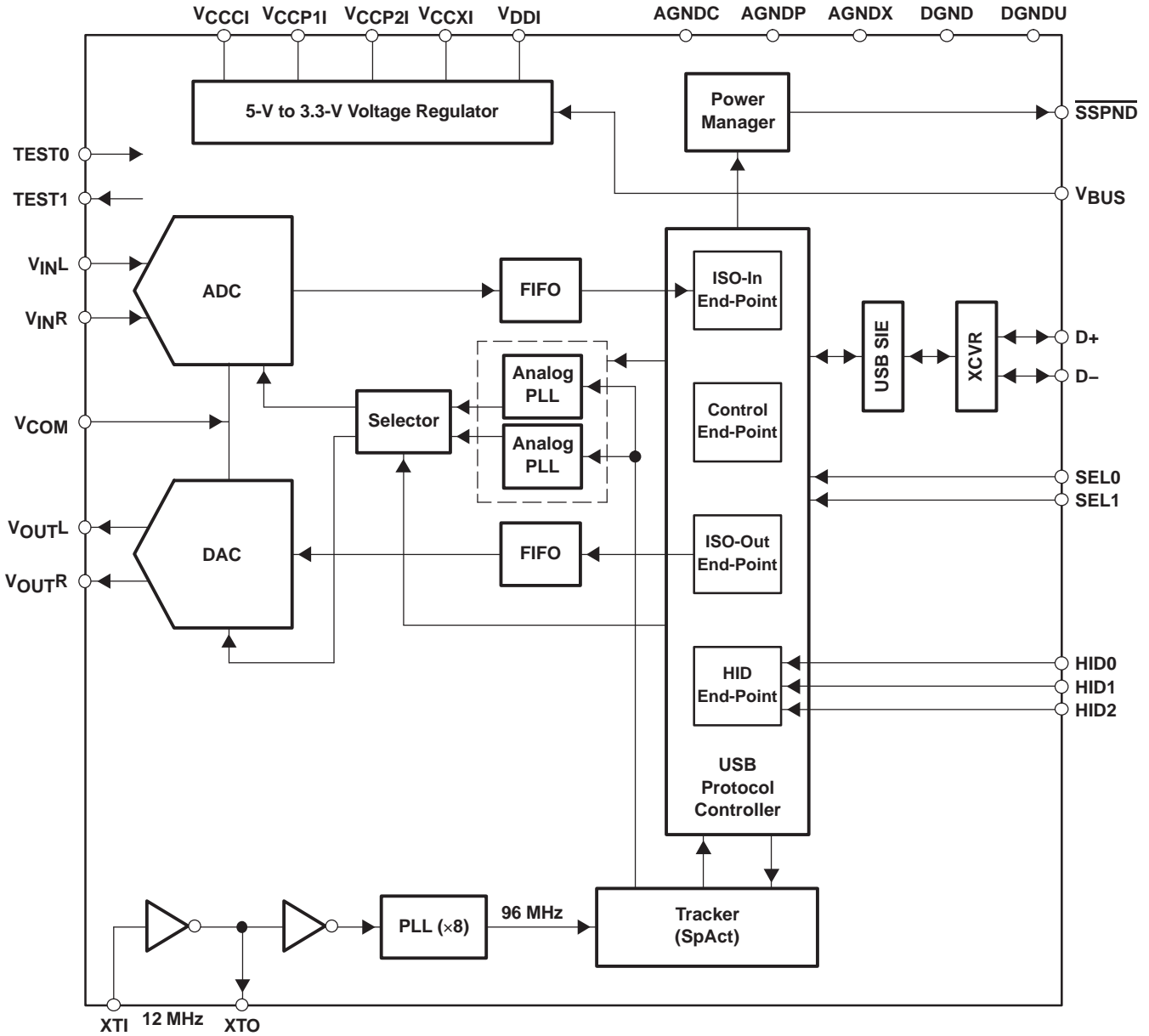

PCM2902 FUNCTIONAL BLOCK DIAGRAM

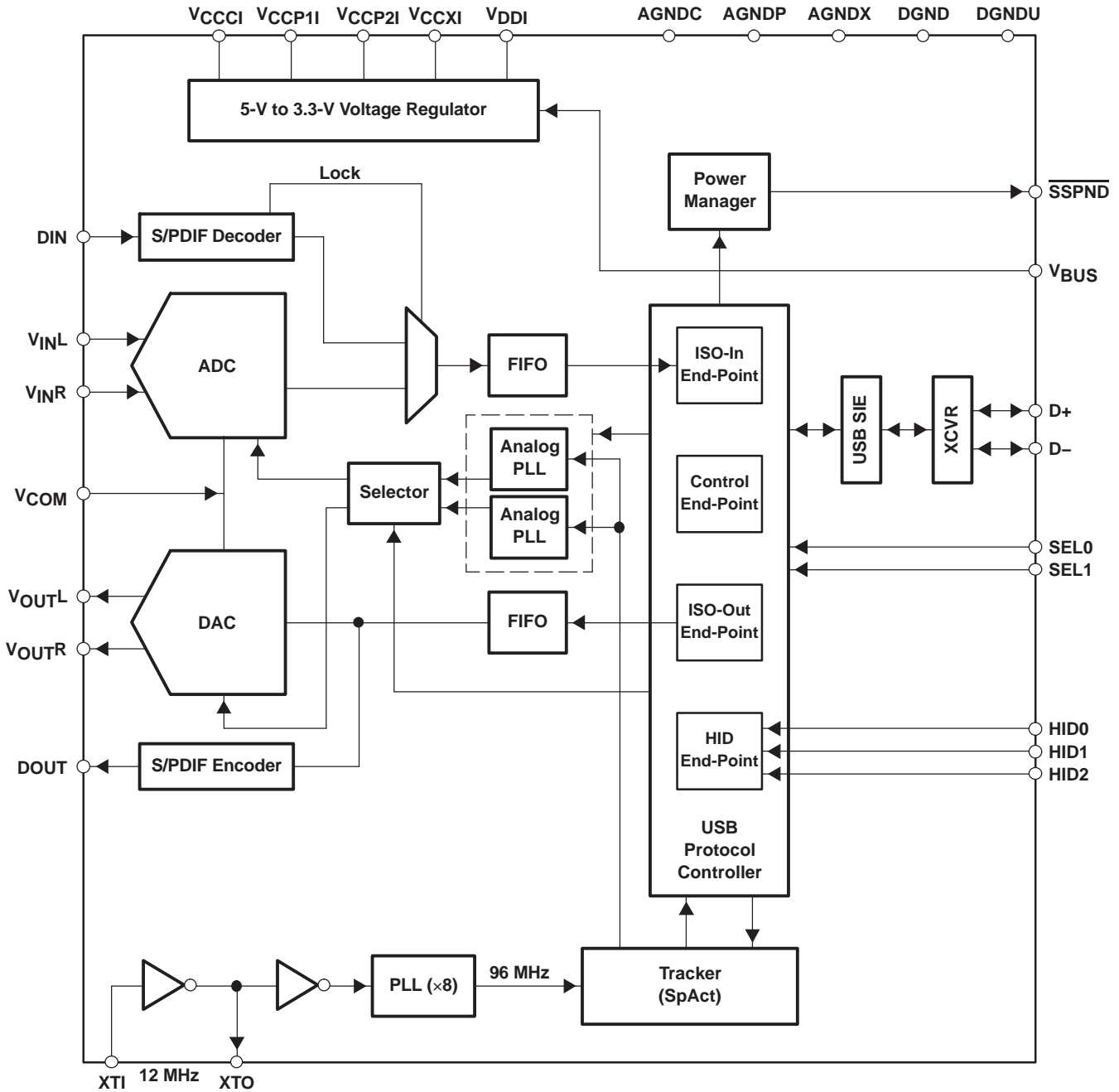

PCM2900/2902 BLOCK DIAGRAM OF ANALOG FRONT-END (RIGHT CHANNEL)

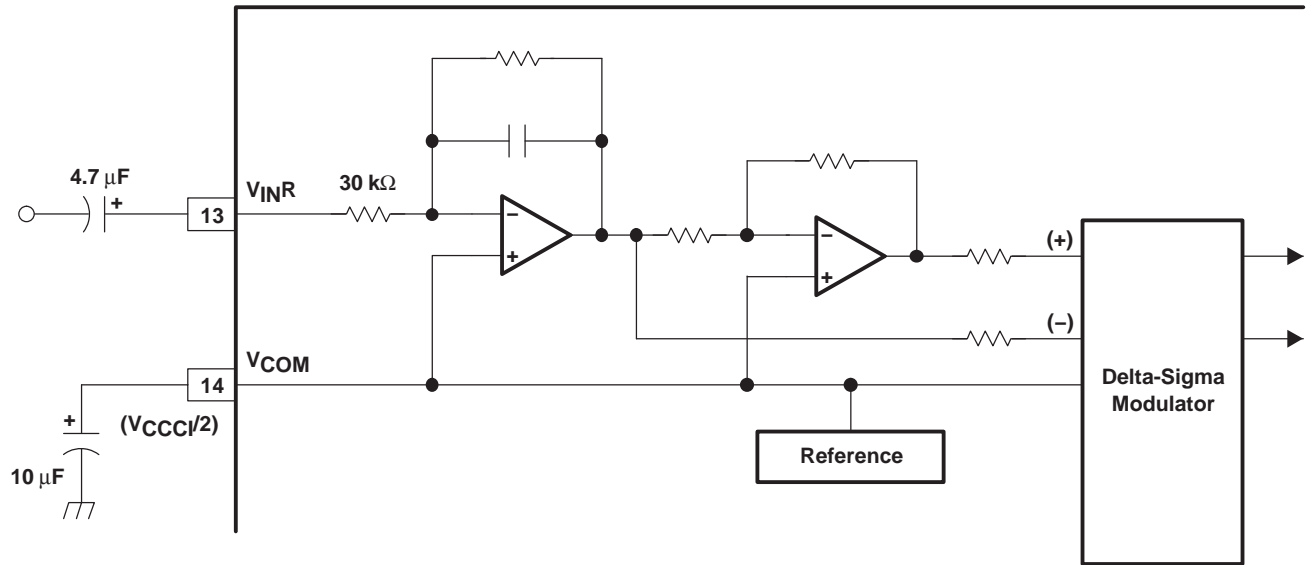

TYPICAL CHARACTERISTICS

ADC

TOTAL HARMONIC DISTORTION + NOISE at -0.5 dB
vs
FREE-AIR TEMPERATURE

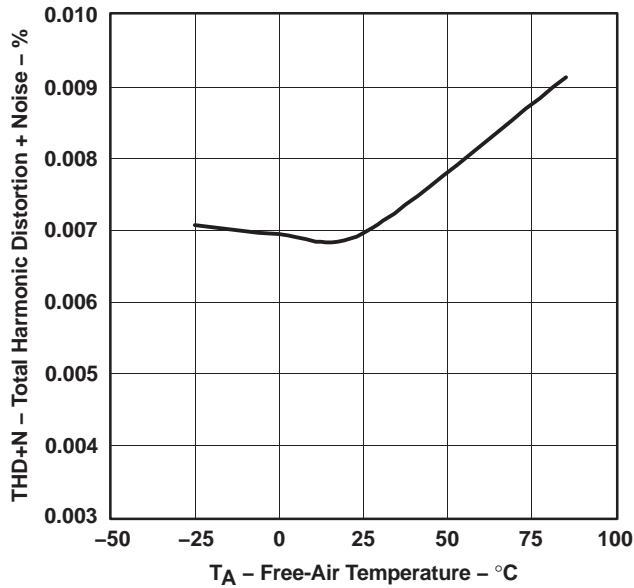

Figure 1

DYNAMIC RANGE and SNR
vs
FREE-AIR TEMPERATURE

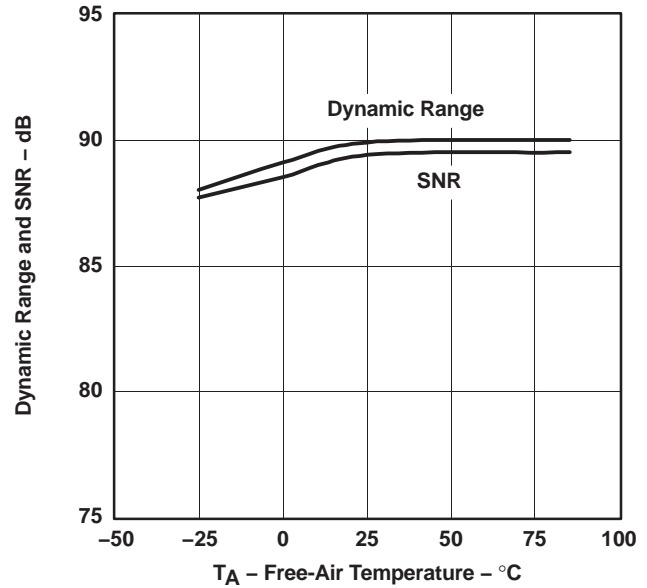

Figure 2

TOTAL HARMONIC DISTORTION + NOISE at -0.5 dB
vs
SUPPLY VOLTAGE

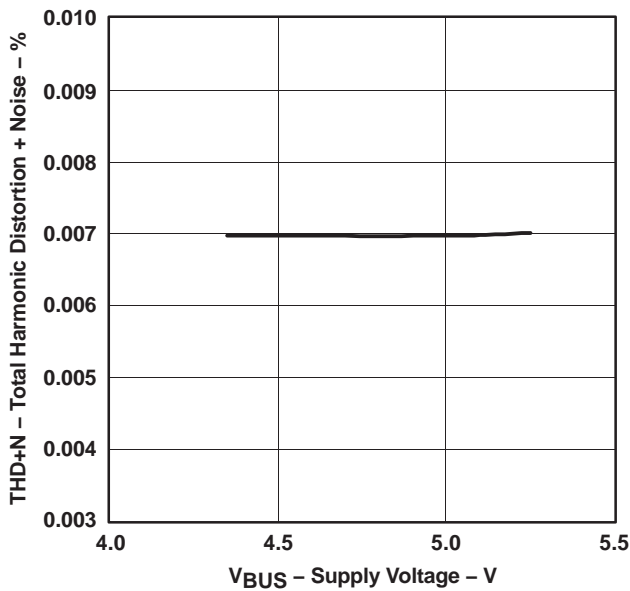

Figure 3

DYNAMIC RANGE and SNR
vs
SUPPLY VOLTAGE

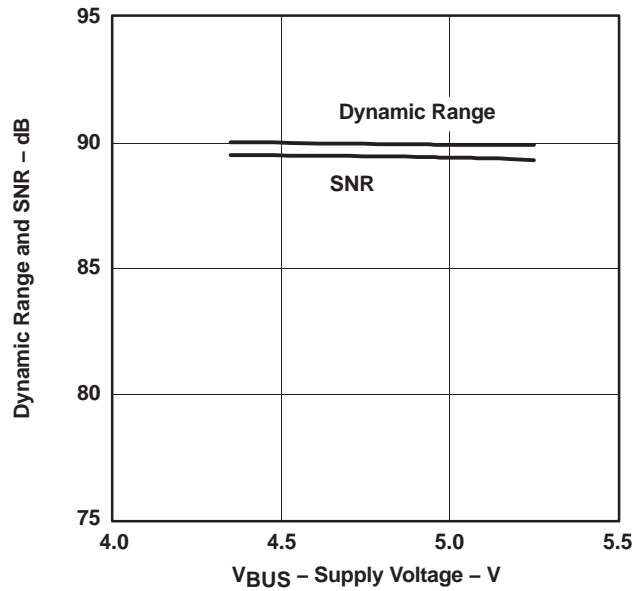
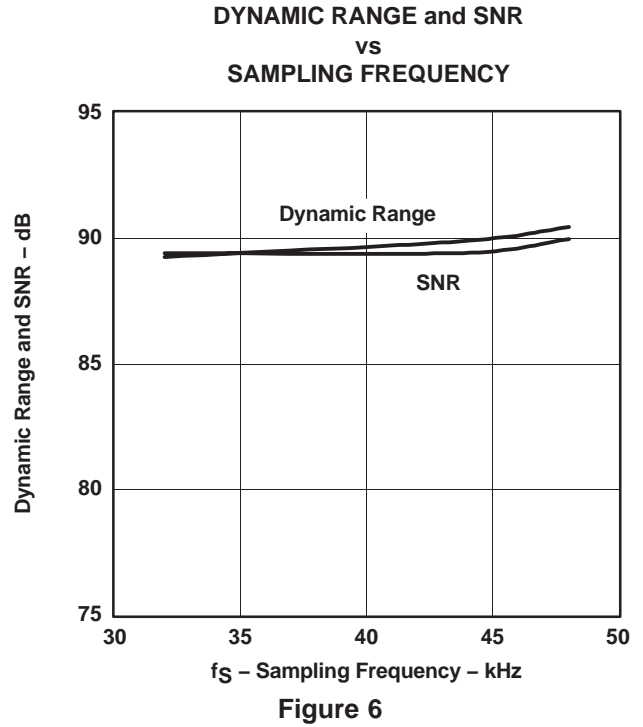
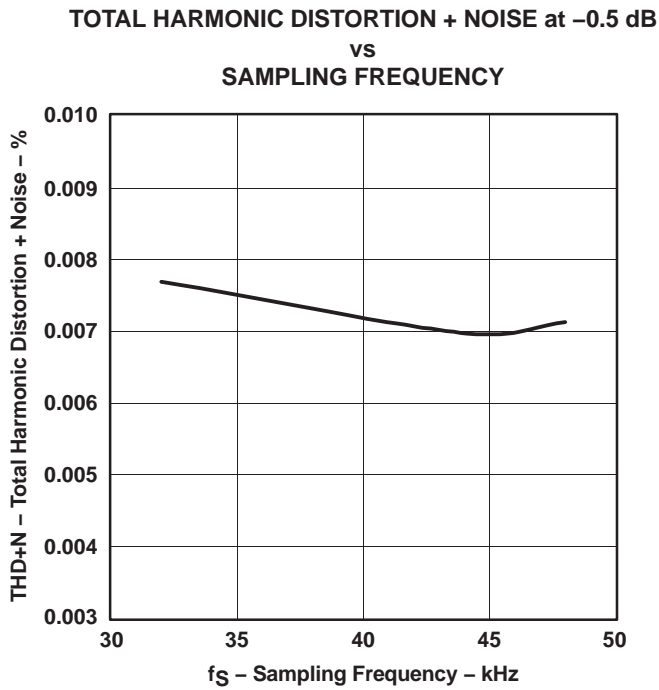

Figure 4

All specifications at TA = 25°C, VBUS = 5 V, fS = 44.1 kHz, fin = 1 kHz, 16-bit data, using REG 103xA-A, unless otherwise noted.

ADC (CONTINUED)



DAC

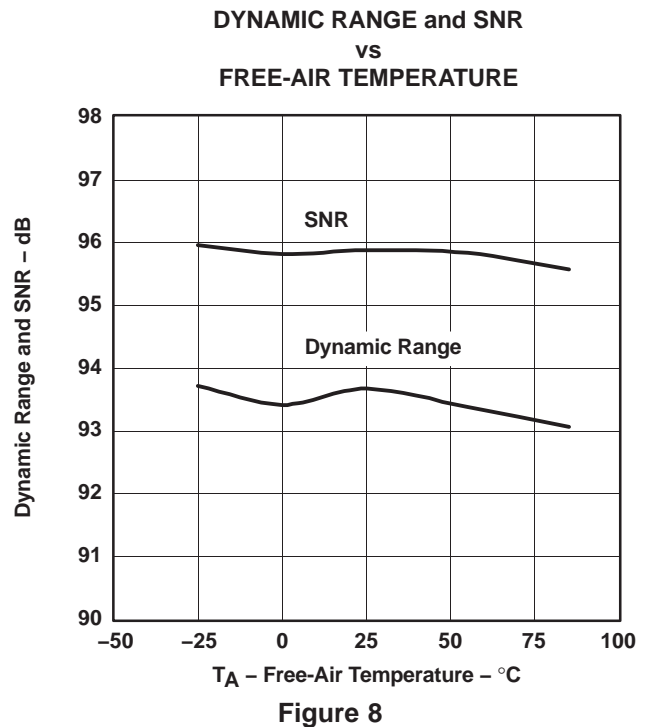
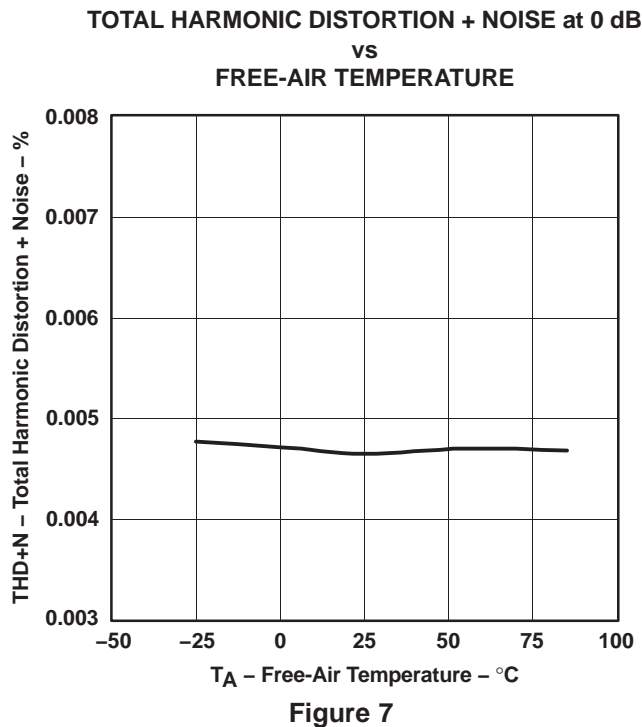

All specifications at T_A = 25°C, V_{BUS} = 5 V, f_S = 44.1 kHz, f_{IN} = 1 kHz, 16-bit data, using REG 103xA-A, unless otherwise noted.

DAC (CONTINUED)

TOTAL HARMONIC DISTORTION + NOISE at 0 dB
vs
SUPPLY VOLTAGE

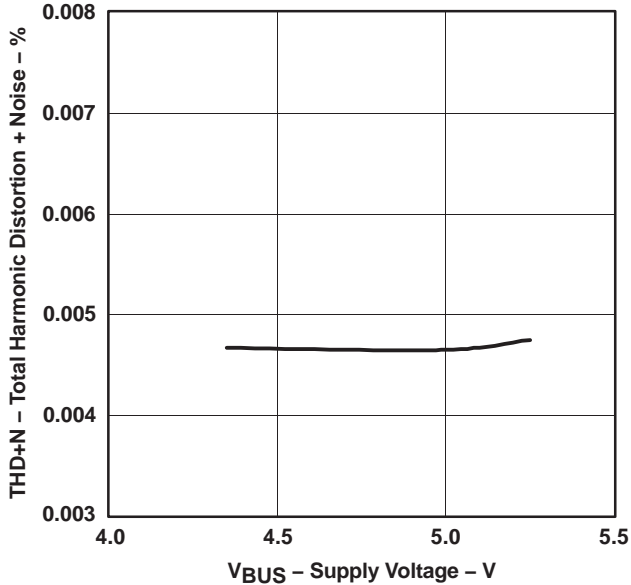

Figure 9

DYNAMIC RANGE and SNR
vs
SUPPLY VOLTAGE

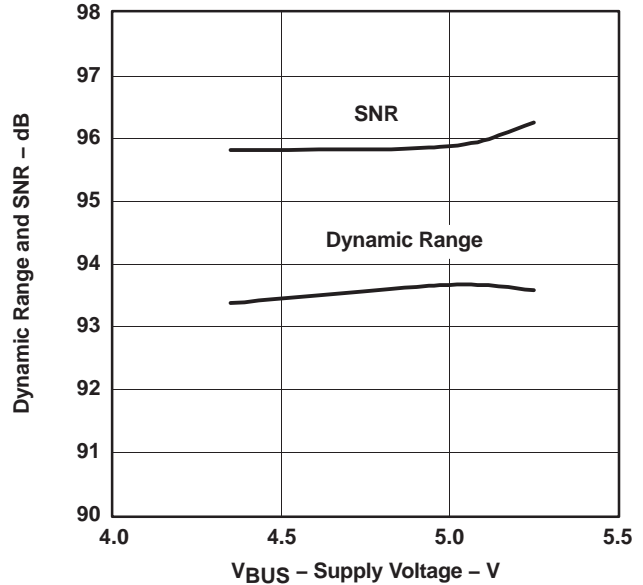

Figure 10

TOTAL HARMONIC DISTORTION + NOISE at 0 dB
vs
SAMPLING FREQUENCY

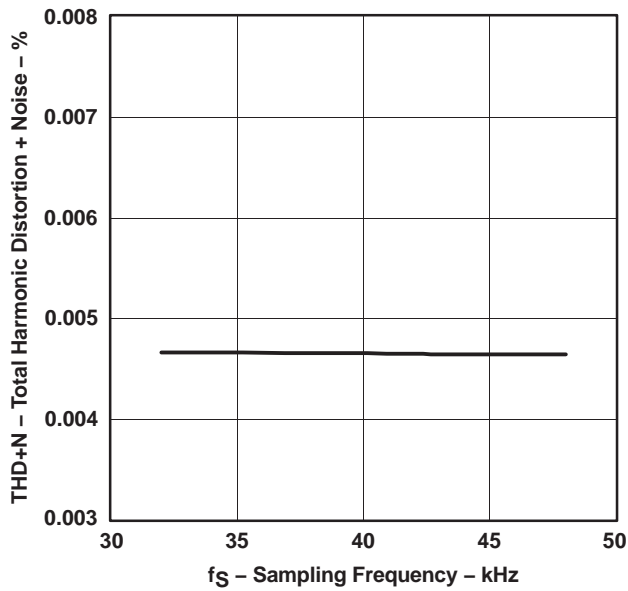

Figure 11

DYNAMIC RANGE and SNR
vs
SAMPLING FREQUENCY

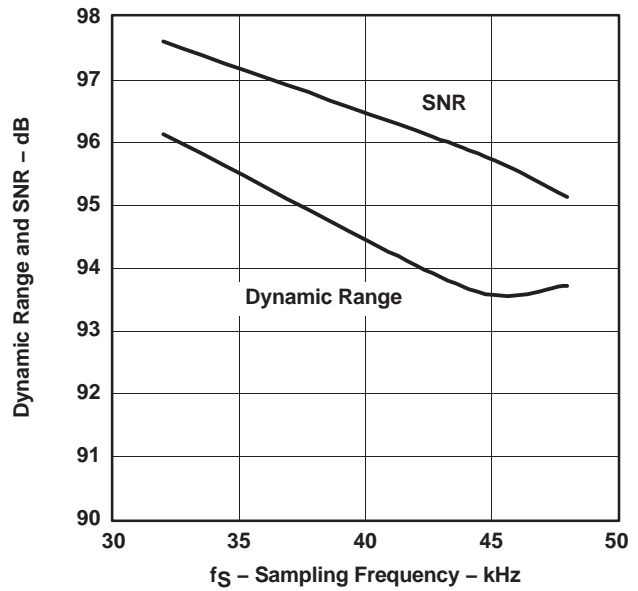

Figure 12

All specifications at $T_A = 25^\circ\text{C}$, $V_{BUS} = 5\text{ V}$, $f_S = 44.1\text{ kHz}$, $f_{in} = 1\text{ kHz}$, 16-bit data, using REG 103xA-A, unless otherwise noted.

SUPPLY CURRENT

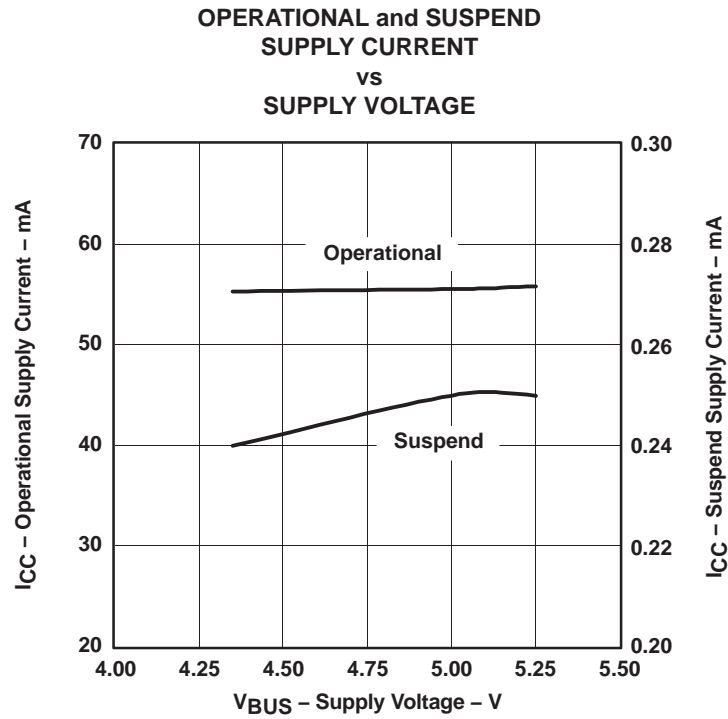

Figure 13

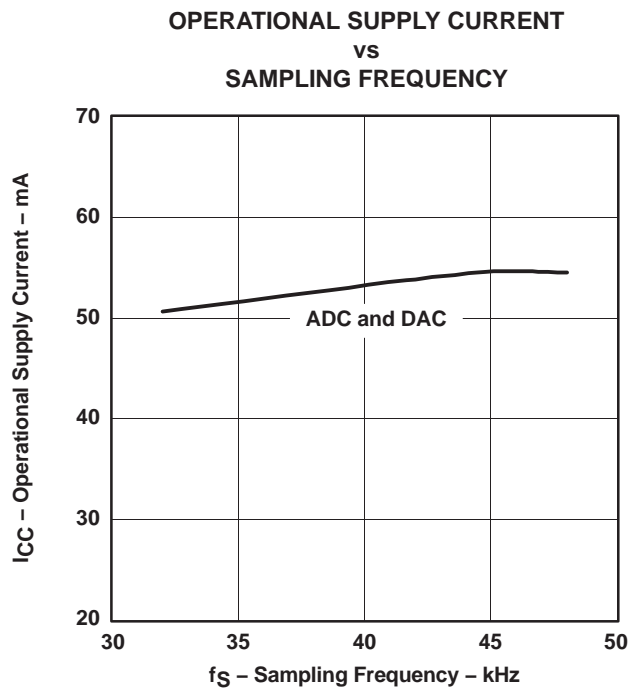

Figure 14

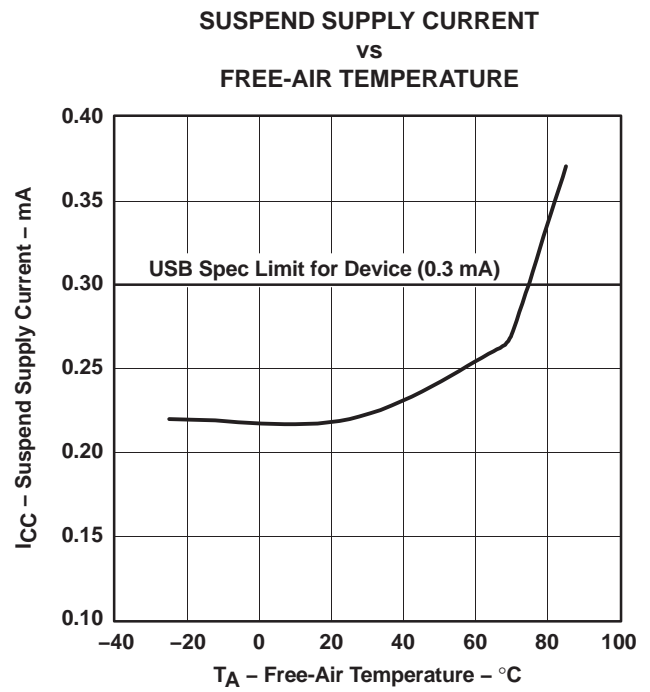

Figure 15

All specifications at T_A = 25°C, V_{BUS} = 5 V, f_S = 44.1 kHz, f_{IN} = 1 kHz, 16-bit data, using REG 103xA-A, unless otherwise noted.

ADC DIGITAL DECIMATION FILTER FREQUENCY RESPONSE

OVERALL CHARACTERISTICS

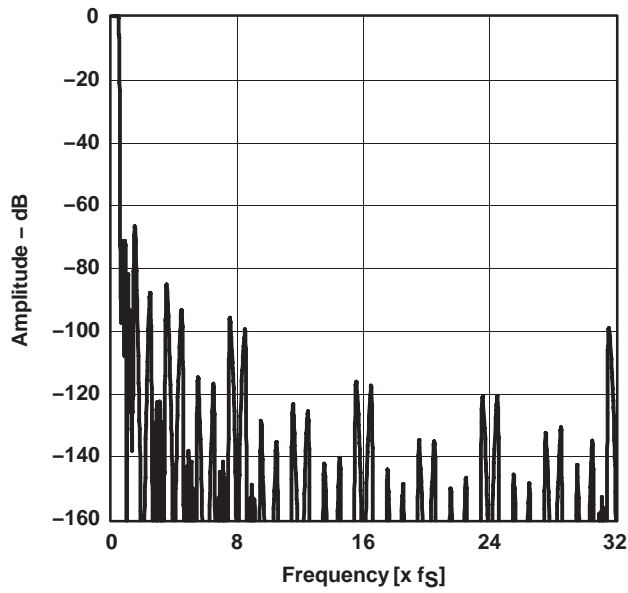

Figure 16

STOP-BAND ATTENUATION

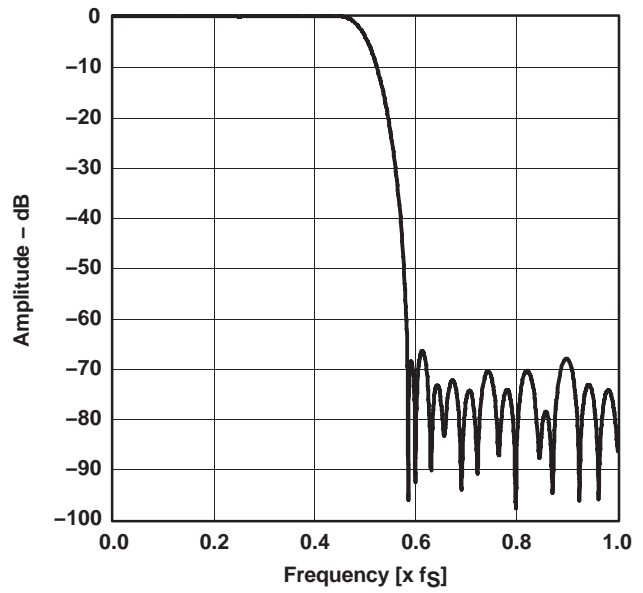

Figure 17

PASS-BAND RIPPLE

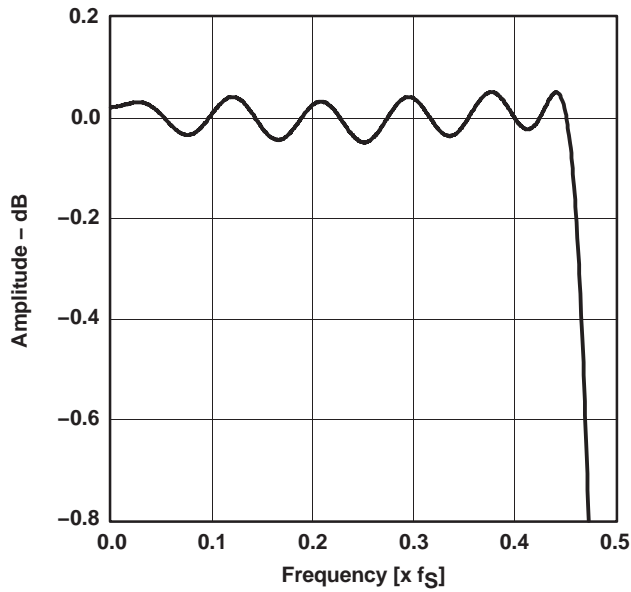

Figure 18

TRANSITION-BAND RESPONSE

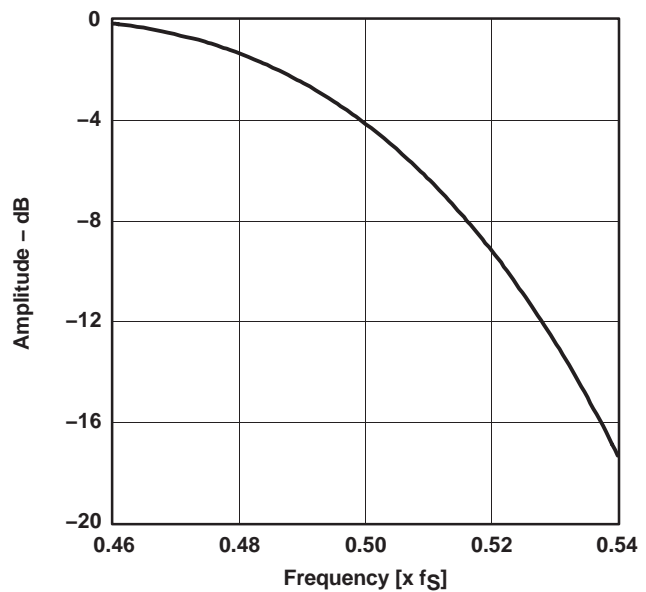
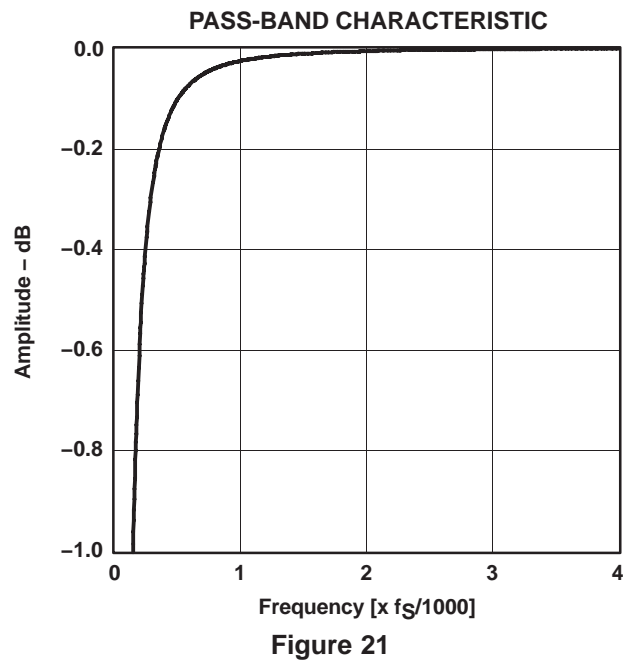
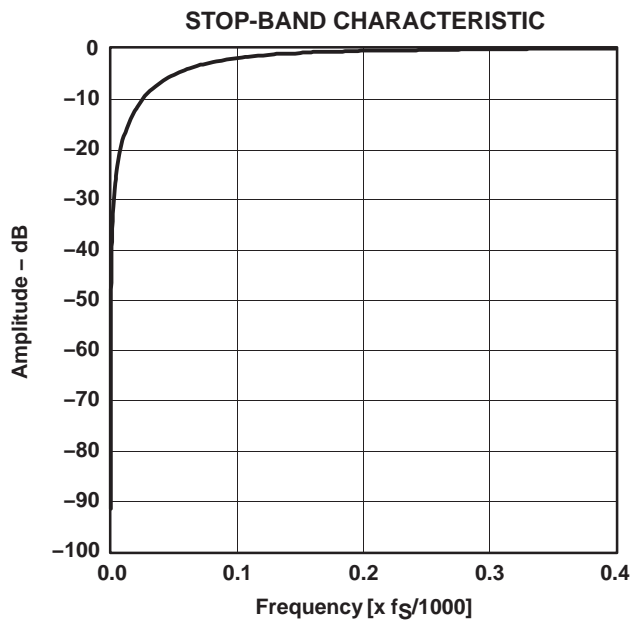

Figure 19

All specifications at $T_A = 25^\circ\text{C}$, $V_{BUS} = 5\text{ V}$, $f_S = 44.1\text{ kHz}$, $f_{in} = 1\text{ kHz}$, 16-bit data, unless otherwise noted.

ADC DIGITAL HIGH-PASS FILTER FREQUENCY RESPONSE



ADC ANALOG ANTIALIASING FILTER FREQUENCY RESPONSE

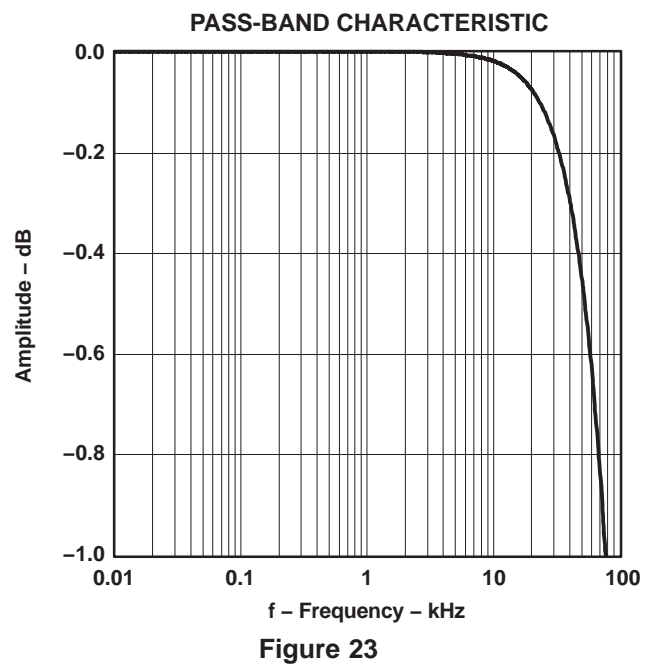
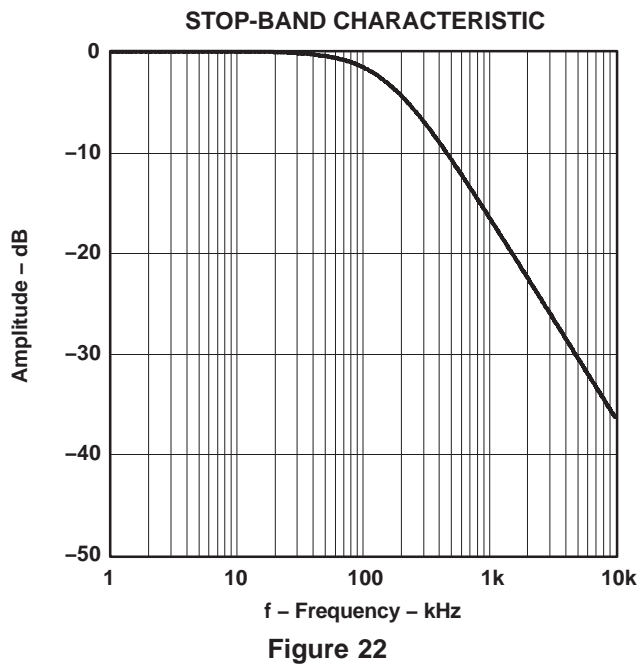

All specifications at $T_A = 25^\circ\text{C}$, $V_{BUS} = 5\text{ V}$, $f_S = 44.1\text{ kHz}$, $f_{in} = 1\text{ kHz}$, 16-bit data, unless otherwise noted.

DAC DIGITAL INTERPOLATION FILTER FREQUENCY RESPONSE

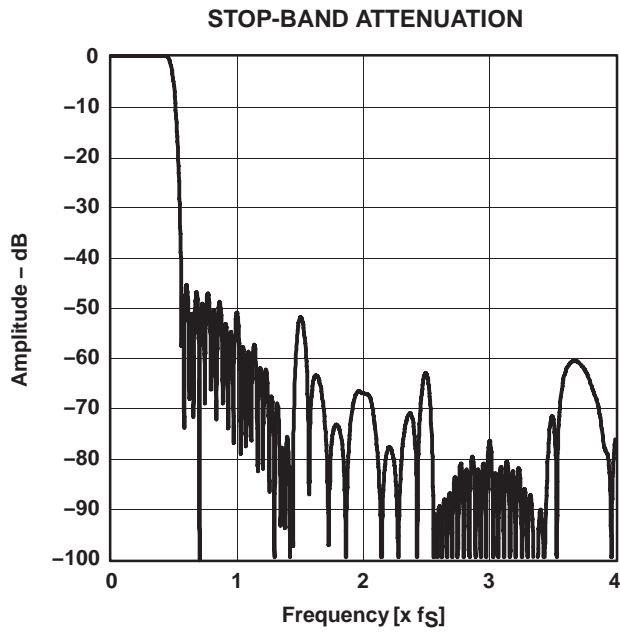

Figure 24

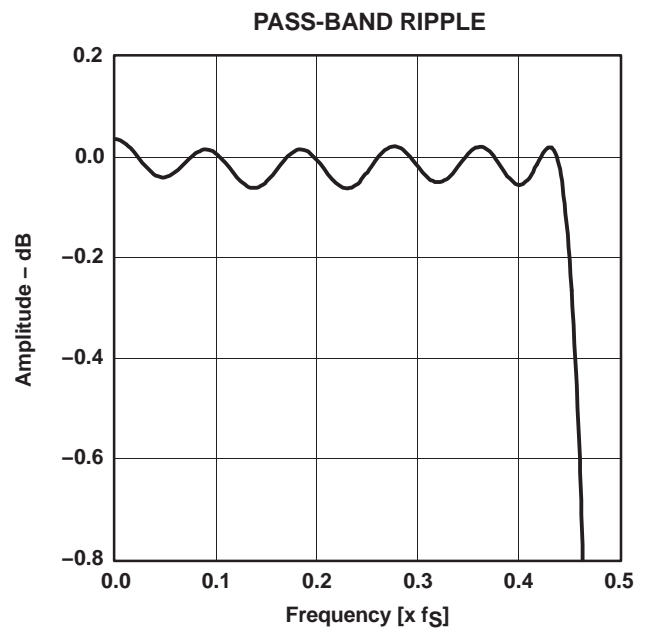

Figure 25

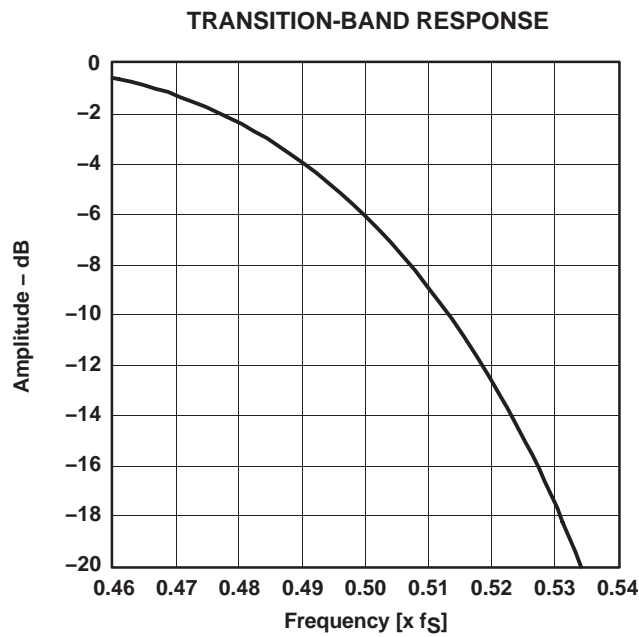

Figure 26

All specifications at $T_A = 25^\circ\text{C}$, $V_{BUS} = 5\text{ V}$, $f_S = 44.1\text{ kHz}$, $f_{in} = 1\text{ kHz}$, 16-bit data, unless otherwise noted.

DAC ANALOG FIR FILTER FREQUENCY RESPONSE

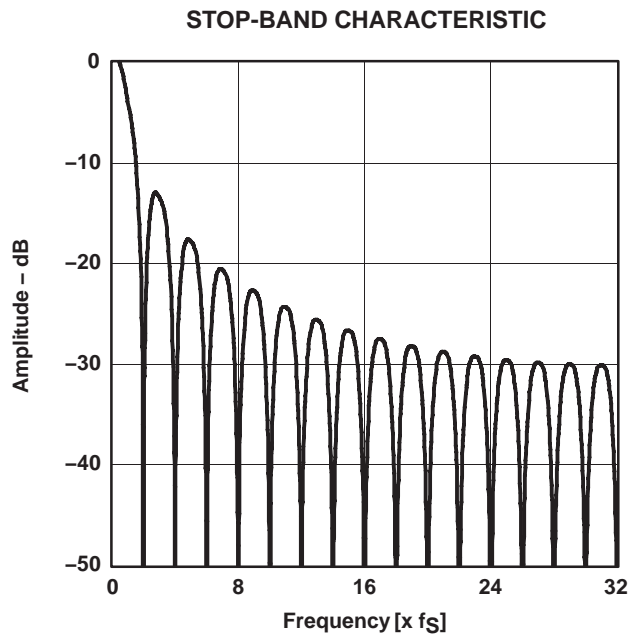

Figure 27

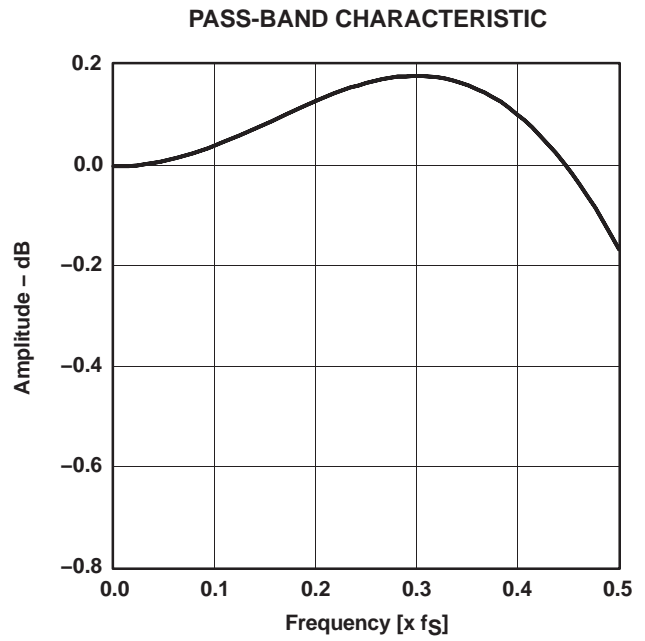

Figure 28

DAC ANALOG LOW-PASS FILTER FREQUENCY RESPONSE

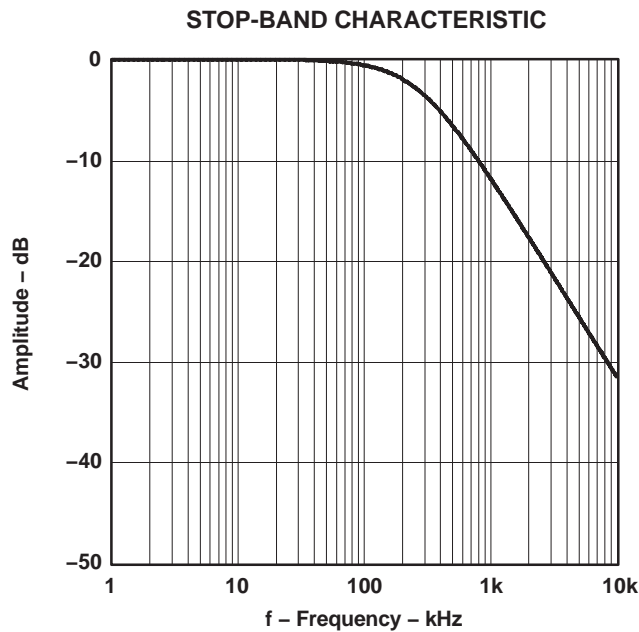

Figure 29

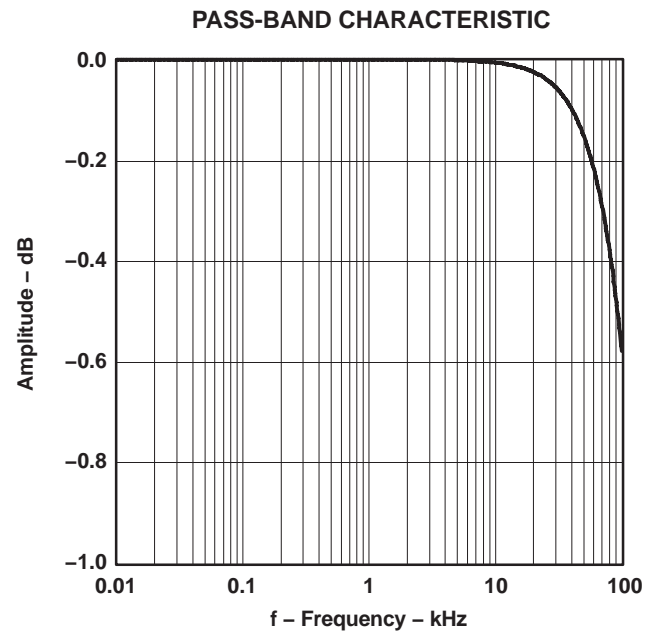

Figure 30

All specifications at $T_A = 25^\circ\text{C}$, $V_{BUS} = 5\text{ V}$, $f_S = 44.1\text{ kHz}$, $f_{in} = 1\text{ kHz}$, 16-bit data, unless otherwise noted.

USB INTERFACE

Control data and audio data are transferred to the PCM2900/2902 via D+ (pin 1) and D– (pin 2). All data to/from the PCM2900/2902 is transferred at full speed. The device descriptor contains the information described in Table 1. The device descriptor can be modified on request; contact a Texas Instruments representative for details.

Table 1. Device Descriptor

| | |
|---------------------------------|--|
| USB revision | 1.1 compliant |
| Device class | 0x00 (device defined interface level) |
| Device sub class | 0x00 (not specified) |
| Device protocol | 0x00 (not specified) |
| Max packet size for end-point 0 | 8 byte |
| Vendor ID | 0x08BB (default value, can be modified) |
| Product ID | 0x2900 / 0x2902 (default value, can be modified) |
| Device release number | 1.0 (0x0100) |
| Number of configurations | 1 |
| Vendor strings | String #1 (see Table 3) |
| Product strings | String #2 (see Table 3) |
| Serial number | Not supported |

The configuration descriptor contains the information described in Table 2. The configuration descriptor can be modified on request; contact a Texas Instruments representative for details.

Table 2. Configuration Descriptor

| | |
|-----------------|---|
| Interface | Four interfaces |
| Power attribute | 0x80 (Bus powered, no remote wakeup) |
| Max power | 0x32 (100 mA. Default value, can be modified) |

The string descriptor contains the information described in Table 3. The string descriptor can be modified on request; contact a Texas Instruments representative for details.

Table 3. String Descriptor

| | |
|----|---|
| #0 | 0x0409 |
| #1 | Burr-Brown from TI (default value, can be modified) |
| #2 | USB audio codec (default value, can be modified) |

DEVICE CONFIGURATION

Figure 31 illustrates the USB audio function topology. The PCM2900/2902 has four interfaces. Each interface is constructed by alternative settings.

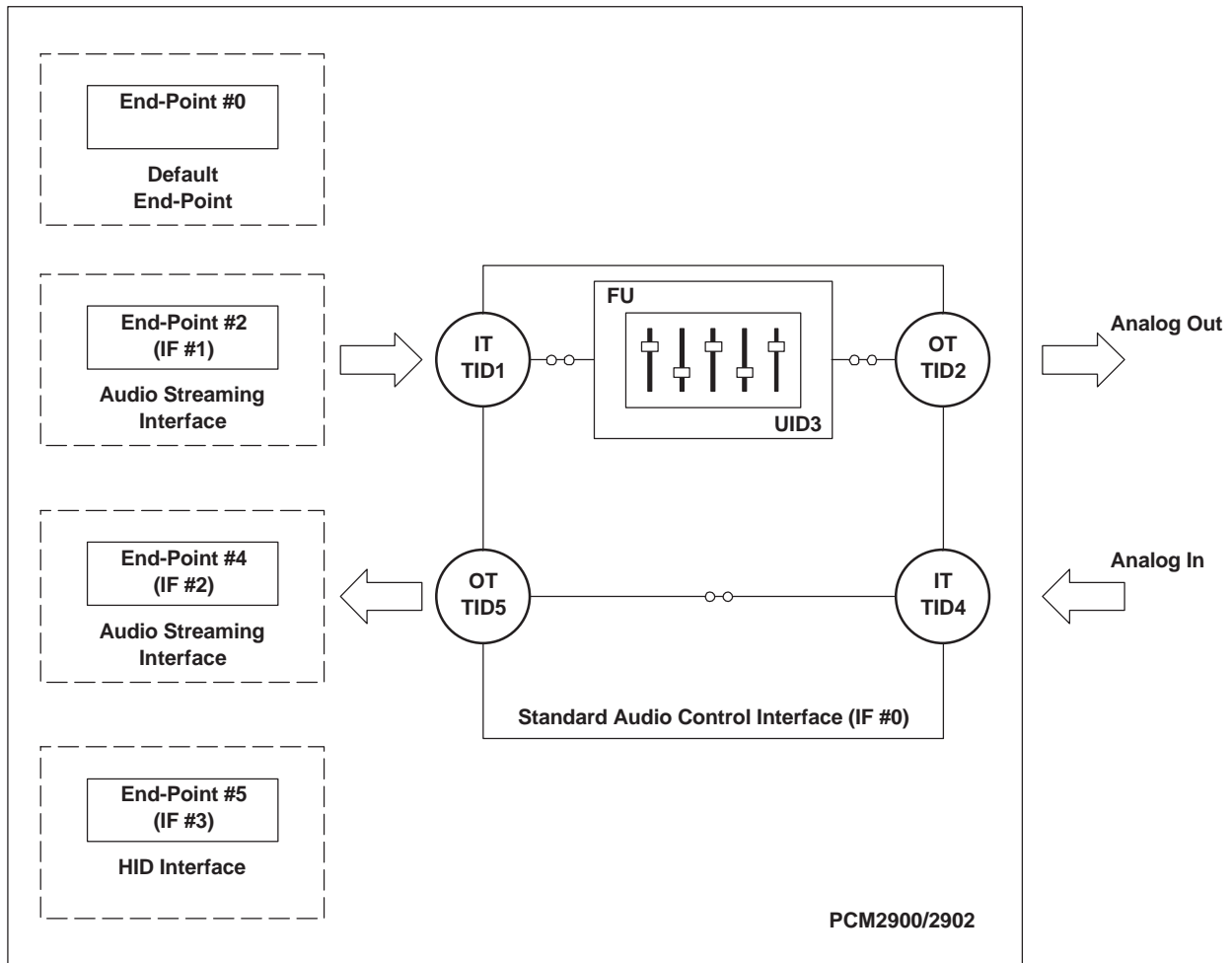

Figure 31. USB Audio Function Topology

Interface #0

Interface #0 is defined as the control interface. Alternative setting #0 is the only possible setting for interface #0. Alternative setting #0 describes the standard audio control interface. A terminal constructs the audio control interface. The PCM2900/2902 has five terminals as follows:

- Input terminal (IT #1) for isochronous-out stream
- Output terminal (OT #2) for audio analog output
- Feature unit (FU #3) for DAC digital attenuator
- Input terminal (IT #4) for audio analog input
- Output terminal (OT #5) for isochronous-in stream

Input terminal #1 is defined as USB stream (terminal type 0x0101). Input terminal #1 can accept 2-channel audio streams constructed by left and right channels. Output terminal #2 is defined as a speaker (terminal type 0x0301). Input terminal #4 is defined as a microphone (terminal type 0x0201). Output terminal #5 is defined as a USB stream (terminal type 0x0101). Output terminal #5 can generate 2-channel audio streams constructed by left and right channels. Feature unit #3 supports the following sound control features.

- Volume control
- Mute control

The built-in digital volume controller can be manipulated by an audio class specific request from 0 dB to –64 dB in 1-dB steps. Changes are made by incrementing or decrementing by one step (1 dB) for every $1/f_s$ time interval until the volume level has reached the requested value. Each channel can be set for different values. The master

volume control is not supported. A request to the master volume is stalled and ignored. The built-in digital mute controller can be manipulated by audio class specific request. A master mute control request is acceptable. A request to an individual channel is stalled and ignored.

Interface #1

Interface #1 is the audio streaming data-out interface. Interface #1 has the following seven alternative settings. Alternative setting #0 is the zero bandwidth setting. All other alternative settings are operational settings.

| ALTERNATIVE SETTING | DATA FORMAT | | | TRANSFER MODE | SAMPLING RATE (kHz) |
|---------------------|----------------|--------|----------------------|---------------|---------------------|
| 00 | Zero Bandwidth | | | | |
| 01 | 16 bit | Stereo | 2s complement (PCM) | Adaptive | 32, 44.1, 48 |
| 02 | 16 bit | Mono | 2s complement (PCM) | Adaptive | 32, 44.1, 48 |
| 03 | 8 bit | Stereo | 2s complement (PCM) | Adaptive | 32, 44.1, 48 |
| 04 | 8 bit | Mono | 2s complement (PCM) | Adaptive | 32, 44.1, 48 |
| 05 | 8 bit | Stereo | Offset binary (PCM8) | Adaptive | 32, 44.1, 48 |
| 06 | 8 bit | Mono | Offset binary (PCM8) | Adaptive | 32, 44.1, 48 |

Interface #2

Interface #2 is the audio streaming data-in the interface. Interface #2 has the following 19 alternative settings. Alternative setting #0 is the zero bandwidth setting. All other alternative settings are operational settings.

| ALTERNATIVE SETTING | DATA FORMAT | | | TRANSFER MODE | SAMPLING RATE (kHz) |
|---------------------|----------------|--------|---------------------|---------------|---------------------|
| 00 | Zero Bandwidth | | | | |
| 01 | 16 bit | Stereo | 2s complement (PCM) | Asynchronous | 48 |
| 02 | 16 bit | Mono | 2s complement (PCM) | Asynchronous | 48 |
| 03 | 16 bit | Stereo | 2s complement (PCM) | Asynchronous | 44.1 |
| 04 | 16 bit | Mono | 2s complement (PCM) | Asynchronous | 44.1 |
| 05 | 16 bit | Stereo | 2s complement (PCM) | Asynchronous | 32 |
| 06 | 16 bit | Mono | 2s complement (PCM) | Asynchronous | 32 |
| 07 | 16 bit | Stereo | 2s complement (PCM) | Asynchronous | 22.05 |
| 08 | 16 bit | Mono | 2s complement (PCM) | Asynchronous | 22.05 |
| 09 | 16 bit | Stereo | 2s complement (PCM) | Asynchronous | 16 |
| 0A | 16 bit | Mono | 2s complement (PCM) | Asynchronous | 16 |
| 0B | 8 bit | Stereo | 2s complement (PCM) | Asynchronous | 16 |
| 0C | 8 bit | Mono | 2s complement (PCM) | Asynchronous | 16 |
| 0D | 8 bit | Stereo | 2s complement (PCM) | Asynchronous | 8 |
| 0E | 8 bit | Mono | 2s complement (PCM) | Asynchronous | 8 |
| 0F | 16 bit | Stereo | 2s complement (PCM) | Synchronous | 11.025 |
| 10 | 16 bit | Mono | 2s complement (PCM) | Synchronous | 11.025 |
| 11 | 8 bit | Stereo | 2s complement (PCM) | Synchronous | 11.025 |
| 12 | 8 bit | Mono | 2s complement (PCM) | Synchronous | 11.025 |

Interface #3

Interface #3 is the interrupt data-in interface. Alternative setting #0 is the only possible setting for interface #3. Interface #3 constructs the HID consumer control device and reports the following three key statuses.

- Mute (0xE209)
- Volume up (0xE909)
- Volume down (0xEA09)

End-Points

The PCM2900/2902 has the following four end-points.

- Control end-point (EP #0)
- Isochronous-out audio data stream end-point (EP #2)
- Isochronous-in audio data stream end-point (EP #4)
- HID end-point (EP #5)

The control end-point is a default end-point. The control end-point is used to control all functions of the PCM2900/2902 by the standard USB request and USB audio class specific request from the host. The isochronous-out audio data stream end-point is an audio sink end-point, which receives the PCM audio data. The isochronous-out audio data stream end-point accepts the adaptive transfer mode. The isochronous-in audio data stream end-point is an audio source end-point, which transmits the PCM audio data. The isochronous-in audio data stream end-point uses asynchronous transfer mode. The HID end-point is an interrupt-in end-point. HID end-point reports HID0, HID1, and HID2 pin status every 32 ms.

The human interface device (HID) pins are defined as consumer control devices. The HID function is designed as an independent end-point from both isochronous-in and -out end-points. This means that the result of affection for the HID operation depends on the host software. Typically, the HID function is affected for the primary audio-out device.

Clock and Reset

The PCM2900/2902 requires a 12-MHz (± 500 ppm) clock for the USB and audio function, which can be generated by a built-in crystal oscillator with a 12-MHz crystal resonator. The 12-MHz crystal resonator must be connected to XTI (pin 21) and XTO (pin 20) with one high (1-M Ω) resistor and two small capacitors, the capacitance of which depends on the load capacitance of the crystal resonator. The external clock can be supplied from XTI (pin 21). If the external clock is supplied, XTO (pin 20) must be left open. Because of no clock-disabling signal, it is not recommended to use the external clock supply. SSPND (pin 28) is unable to use clock disabling.

The PCM2900/2902 has an internal power-on reset circuit, which works automatically when V_{BUS} (pin 3) exceeds 2.5 V typical (2.7 V–2.2 V), and about 700 μ s is required until internal reset release.

Digital Audio Interface (PCM2902)

The PCM2902 employs both S/PDIF input and output. Isochronous-out data from the host is encoded to the S/PDIF output and the DAC analog output. Input data is selected as either S/PDIF or ADC analog input. When the device detects an S/PDIF input and successfully locks the received data, the isochronous-in transfer data source is automatically selected from S/PDIF itself; otherwise, the data source is selected to ADC analog input.

Supported Input Data (PCM2902)

The following data formats are accepted by the S/PDIF input and output. All other data formats are unable to use S/PDIF.

- 48-kHz 16-bit stereo
- 44.1-kHz 16-bit stereo
- 32-kHz 16-bit stereo

Mismatch between input data format and host command may cause unexpected results except in the following conditions.

- Record monaural format from stereo data input at the same data rate
- Record 8-bit format from 16-bit data input at the same data rate

A combination between the above conditions is not accepted.

For the playback, all possible data rate source is converted to 16-bit stereo format at the same source data rate.

Channel Status Information (PCM2902)

The channel status information is fixed as consumer application, PCM mode, copyright, and digital/digital converter. All other bits are fixed as 0s except for the sample frequency, which is set automatically according to the data received through the USB.

Copyright Management (PCM2902)

Isochronous-in data is affected by the serial copy management system (SCMS). When receiving digital audio data that is indicated as original data in the control bit, input digital audio data transfers to the host. If the data is indicated as first generation or higher, transferred data is selected to analog input.

Digital audio data output is always encoded as original with SCMS control.

The implementation of this feature is an option for the customer. Note that it is the user's responsibility whether they implement this feature in their product or not.

INTERFACE SEQUENCE

Power On, Attach, and Playback Sequence

The PCM2900/2902 is ready for setup when the reset sequence has finished and the USB bus is attached. After connection has been established by setup, the PCM2900/2902 is ready to accept USB audio data. While waiting, the audio data (idle state) and analog output are set to bipolar zero (BPZ).

When receiving the audio data, the PCM2900/2902 stores the first audio packet, which contained 1-ms audio data, into the internal storage buffer. The PCM2900/2902 starts playing the audio data when detecting the following start of frame (SOF) packet.

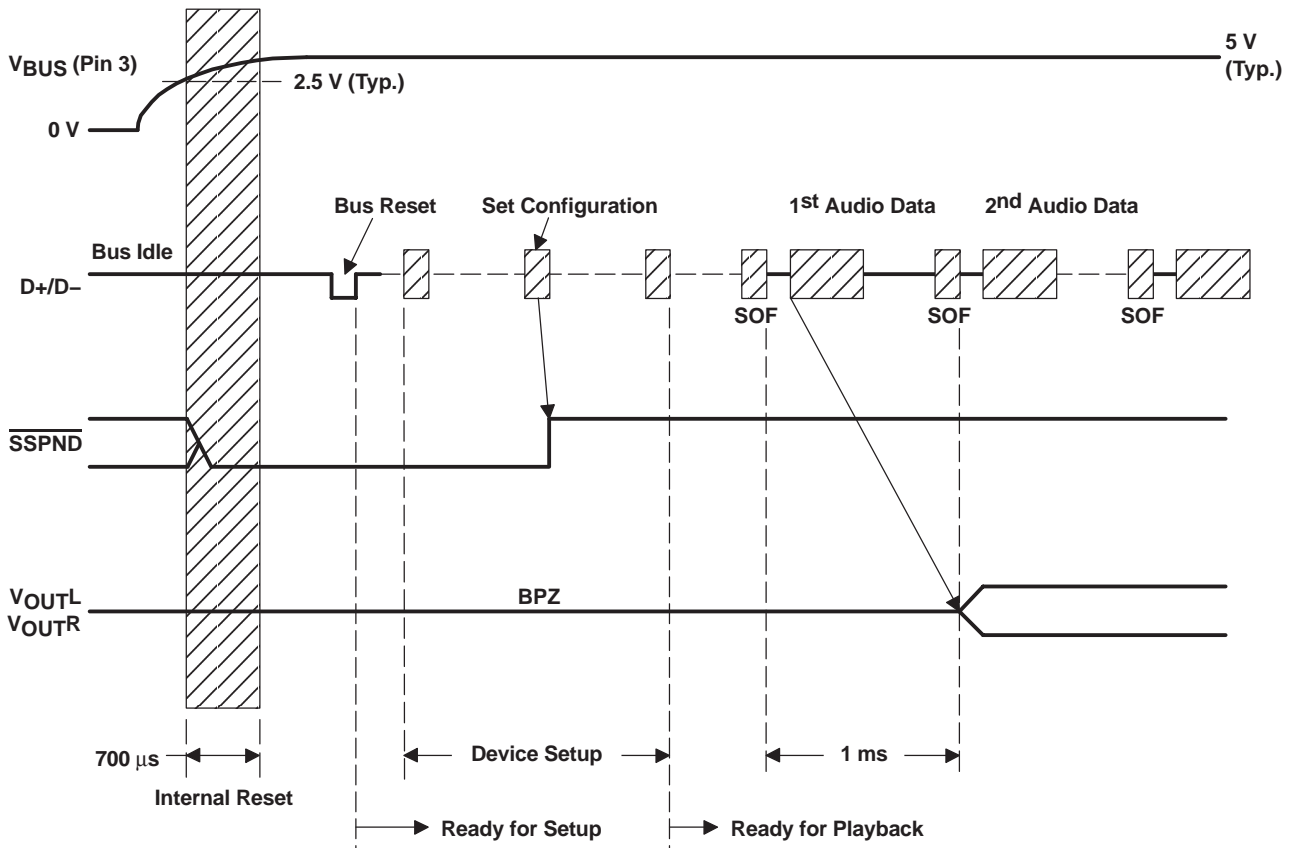

Figure 32. Initial Sequence

Play, Stop, and Detach Sequence

When the host finishes or aborts the playback, the PCM2900/2902 stops playing after the last audio data has played.

Record Sequence

The PCM2900/2902 starts the audio capture into the internal memory after receiving the SET_INTERFACE command.

Suspend and Resume Sequence

The PCM2900/2902 enters the suspend state after it sees a constant idle state on the USB bus, approximately 5 ms. While the PCM2900/2902 enters the suspend state, \overline{SSPND} flag (pin 28) is asserted. The PCM2900/2902 wakes up immediately when detecting the non-idle state on the USB bus.

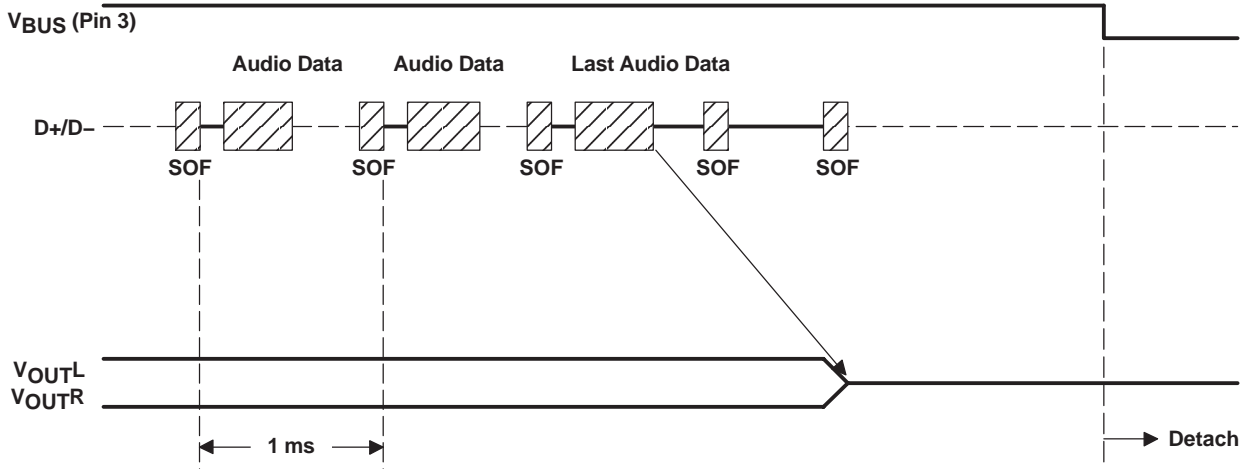

Figure 33. Play, Stop, and Detach

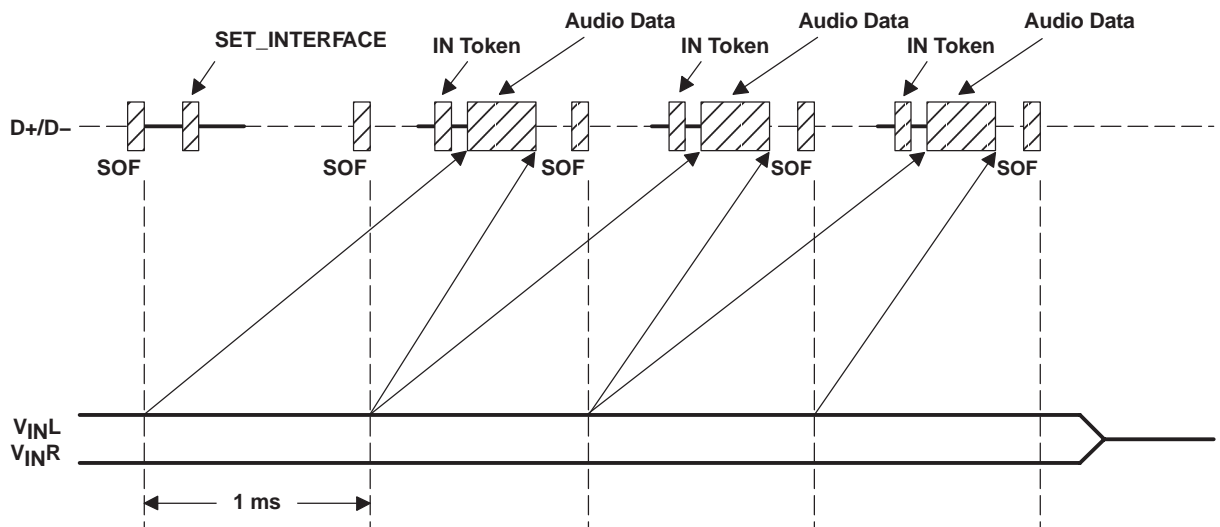

Figure 34. Record Sequence

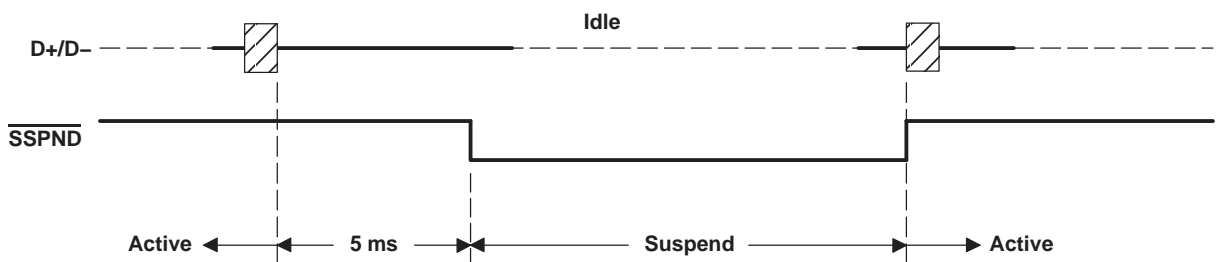
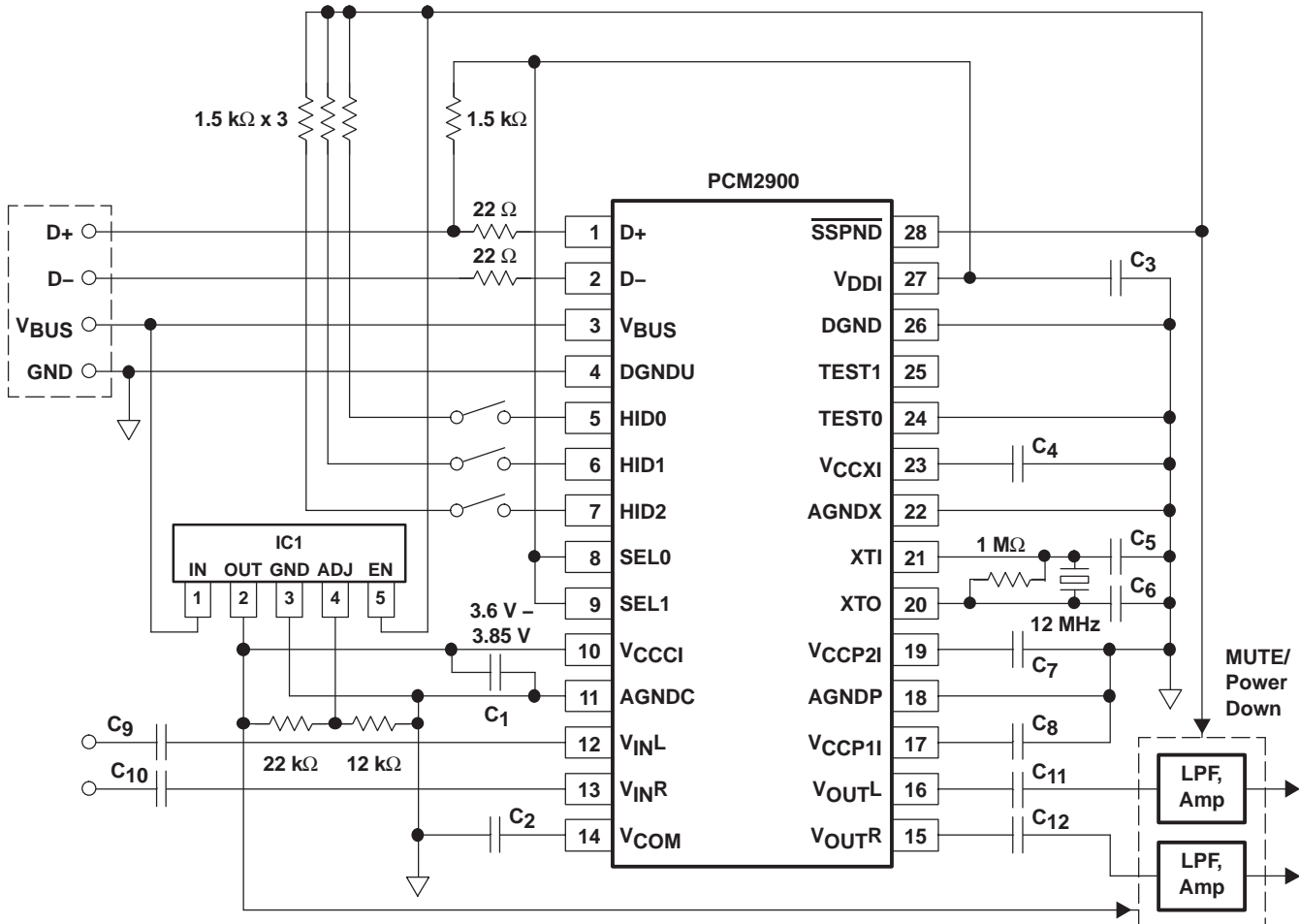

Figure 35. Suspend and Resume

PCM2900 TYPICAL CIRCUIT CONNECTION 1

Figure 36 illustrates a typical circuit connection for a high-performance application. The circuit illustrated is for information only. The whole board design should be considered to meet the USB specification as a USB-compliant product.



NOTE: C1, C2: 10 μ F
 C3, C4, C7, C8: 1 μ F (These capacitors must be less than 2 μ F)
 C5, C6: 10 pF to 33 pF (depending on crystal resonator)
 C9, C10, C11, C12: The capacitance may vary depending on design.
 IC1: REG103xA-A (TI) or equivalent. Analog performance may vary depending on IC1.

Figure 36. Bus-Powered Configuration for High-Performance Application

PCM2902 TYPICAL CIRCUIT CONNECTION 1

Figure 37 illustrates a typical circuit connection for a high-performance application. The circuit illustrated is for information only. The whole board design should be considered to meet the USB specification as a USB-compliant product.

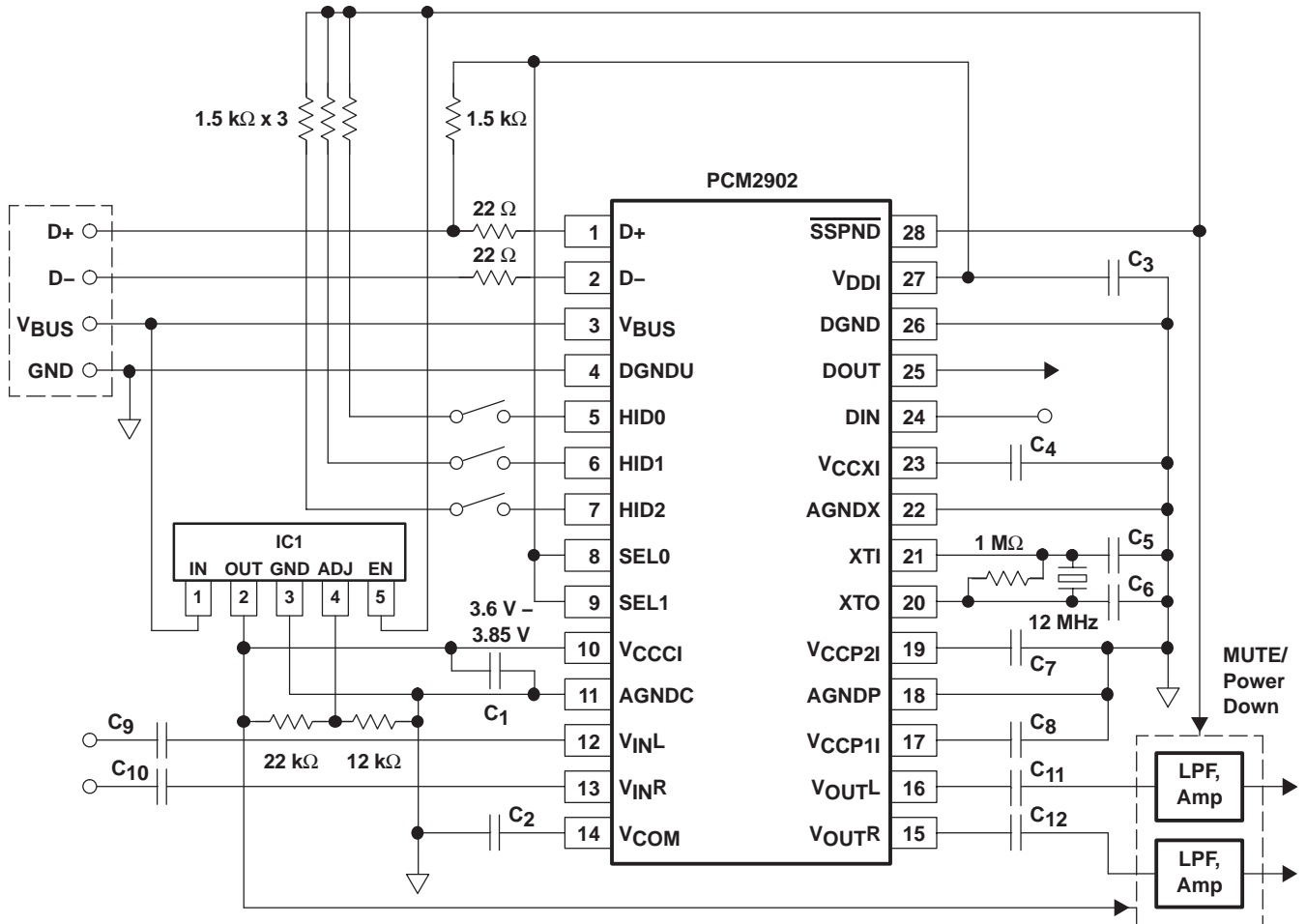

NOTE: C₁, C₂: 10 μF
 C₃, C₄, C₇, C₈: 1 μF (These capacitors must be less than 2 μF)
 C₅, C₆: 10 pF to 33 pF (depending on crystal resonator)
 C₉, C₁₀, C₁₁, C₁₂: The capacitance may vary depending on design.
 IC1: REG103xA-A (TI) or equivalent. Analog performance may vary depending on IC1.

Figure 37. Bus-Powered Configuration for High-Performance Application

PCM2902 TYPICAL CIRCUIT CONNECTION 2

Figure 39 illustrates a typical circuit connection for a simple application. The circuit illustrated is for information only. The whole board design should be considered to meet the USB specification as a USB-compliant product.

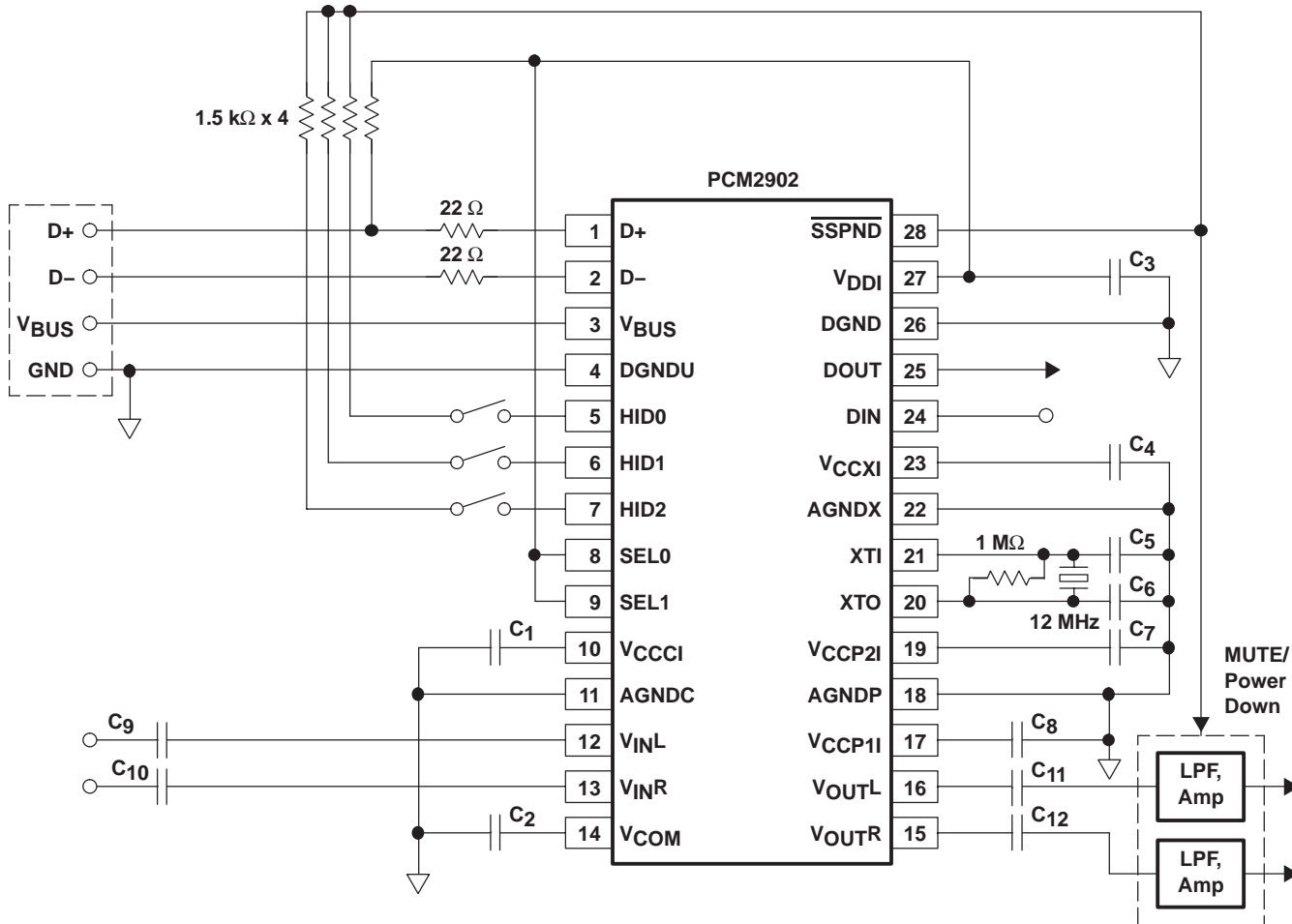

NOTE: C₁, C₂: 10 μF
 C₃, C₄, C₇, C₈: 1 μF (These capacitors must be less than 2 μF.)
 C₅, C₆: 10 pF to 33 pF (depending on crystal resonator)
 C₉, C₁₀, C₁₁, C₁₂: The capacitance may vary depending on design.
 In this case analog performance of the A/D converter may degrade.

Figure 39. Bus-Powered Configuration

APPLICATION INFORMATION

OPERATING ENVIRONMENT

To get the appropriate operation, one of the following operating systems must be working on the host PC that has the USB port assured by the manufacturer. If the condition is fulfilled, the operation of the PCM2900/2902 does not depend on the operating speed of the CPU.

Texas Instruments has confirmed following operating environments.

- Operating System
 - Microsoft™ Windows™ 98/98SE/Me™ Japanese/English Edition
 - Microsoft Windows 2000 Professional Japanese/English Edition
 - Microsoft Windows XP™ Home/Professional Japanese/English Edition (For Windows™ XP, use the latest version of the USB audio driver that is available on Windows update site)
 - Apple™ Computer Mac™ OS 9.1 or later Japanese/English Edition
 - Apple Computer Mac OS™ X 10.0 or later English Edition
 - Apple Computer Mac OS X 10.1 or later Japanese Edition (For Mac OS X 10.0 Japanese Edition, plug and play does not work for USB audio device appropriately)
- PC: Following PC-AT compatible computers for above OS (OS requirement must be met)
 - Motherboard using Intel™ 440BX or ZX chipset (using USB controller in the chipset)
 - Motherboard using Intel i810 chipset (using USB controller in the chipset)
 - Motherboard using Intel i815 chipset (using USB controller in the chipset)
 - Motherboard using Intel i820 chipset (using USB controller in the chipset)
 - Motherboard using Intel i845 chipset (using USB controller in the chipset)
 - Motherboard using Intel i850 chipset (using USB controller in the chipset)
 - Motherboard using Apollo KT133 chipset (using USB controller in the chipset)
 - Motherboard using Apollo Pro plus chipset (using USB controller in the chipset)
 - Motherboard using MVP4 or MVP3 chipset (using USB controller in the chipset)
 - Motherboard using Aladdin V chipset (using USB controller in the chipset)
 - Motherboard using SiS530 or SiS559 chipset (using USB controller in the chipset)
 - Motherboard using SiS735 chipset (using USB controller in the chipset)

NOTE: The OSs and PCs for which the operation of the PCM2900/2902 was confirmed are listed above. The PCM2900/2902 may also work with other OSs and PCs that have not been tested. Furthermore, there is no assurance that the PCM2900/2902 will work with every PC having a compatible chipset, because other design factors of the motherboard may also cause incompatibility.

The PCM2900/2902 has been acknowledged in the USB compliance test. However, the acknowledgement is just for the PCM2900/2902 from Texas Instruments. Be careful that the acknowledgement is not for the customer's USB system using the PCM2900/2902.

DB (R-PDSO-G**)

PLASTIC SMALL-OUTLINE

28 PINS SHOWN



- NOTES: A. All linear dimensions are in millimeters.
 B. This drawing is subject to change without notice.
 C. Body dimensions do not include mold flash or protrusion not to exceed 0,15.
 D. Falls within JEDEC MO-150

IMPORTANT NOTICE

Texas Instruments Incorporated and its subsidiaries (TI) reserve the right to make corrections, modifications, enhancements, improvements, and other changes to its products and services at any time and to discontinue any product or service without notice. Customers should obtain the latest relevant information before placing orders and should verify that such information is current and complete. All products are sold subject to TI's terms and conditions of sale supplied at the time of order acknowledgment.

TI warrants performance of its hardware products to the specifications applicable at the time of sale in accordance with TI's standard warranty. Testing and other quality control techniques are used to the extent TI deems necessary to support this warranty. Except where mandated by government requirements, testing of all parameters of each product is not necessarily performed.

TI assumes no liability for applications assistance or customer product design. Customers are responsible for their products and applications using TI components. To minimize the risks associated with customer products and applications, customers should provide adequate design and operating safeguards.

TI does not warrant or represent that any license, either express or implied, is granted under any TI patent right, copyright, mask work right, or other TI intellectual property right relating to any combination, machine, or process in which TI products or services are used. Information published by TI regarding third-party products or services does not constitute a license from TI to use such products or services or a warranty or endorsement thereof. Use of such information may require a license from a third party under the patents or other intellectual property of the third party, or a license from TI under the patents or other intellectual property of TI.

Reproduction of information in TI data books or data sheets is permissible only if reproduction is without alteration and is accompanied by all associated warranties, conditions, limitations, and notices. Reproduction of this information with alteration is an unfair and deceptive business practice. TI is not responsible or liable for such altered documentation.

Resale of TI products or services with statements different from or beyond the parameters stated by TI for that product or service voids all express and any implied warranties for the associated TI product or service and is an unfair and deceptive business practice. TI is not responsible or liable for any such statements.

Following are URLs where you can obtain information on other Texas Instruments products and application solutions:

| Products | | Applications | |
|------------------|--|---------------------|--|
| Amplifiers | amplifier.ti.com | Audio | www.ti.com/audio |
| Data Converters | dataconverter.ti.com | Automotive | www.ti.com/automotive |
| DSP | dsp.ti.com | Broadband | www.ti.com/broadband |
| Interface | interface.ti.com | Digital Control | www.ti.com/digitalcontrol |
| Logic | logic.ti.com | Military | www.ti.com/military |
| Power Mgmt | power.ti.com | Optical Networking | www.ti.com/opticalnetwork |
| Microcontrollers | microcontroller.ti.com | Security | www.ti.com/security |
| | | Telephony | www.ti.com/telephony |
| | | Video & Imaging | www.ti.com/video |
| | | Wireless | www.ti.com/wireless |

Mailing Address: Texas Instruments
Post Office Box 655303 Dallas, Texas 75265